



Research article

Lagged settlement in sandy cobble strata and earth pressure on shield tunnel

Jizhi Huang¹, Yong Zhang^{2,3,4,*}, Xiaowei Ouyang^{5,*} and Guoyuan Xu¹

¹ School of Civil Engineering & Transportation, South China University of Technology, Guangzhou, Guangdong 510641, China

² Fujian Provincial University Research Center for Advanced Civil Engineering Materials, Fuzhou University, Fuzhou 350116, China

³ College of Civil Engineering, Fuzhou University, Fuzhou 350116, China

⁴ Microlab, Section of Materials and Environment, Department of 3MD, Faculty of Civil Engineering and Geosciences, Delft University of Technology, Stevinweg 1, 2628 CN Delft, The Netherlands

⁵ Guangzhou University-Tamkang University Joint Research Centre for Engineering Structure Disaster Prevention and Control, Guangzhou University, Guangzhou, Guangdong 510006, China

* **Correspondence:** Email: y.zhang-1@tudelft.nl, xwouyang@gzhu.edu.cn.

Abstract: Lagged settlement is a typical accident induced by shield construction in sandy cobble strata. This paper analyzed the process and mechanism of lagged settlement, results show that all phases are in accord with the characteristics of ellipsoid theory of particle flows. Based on this theory, a method for calculating coefficient of lateral earth pressure and loosened earth pressure is proposed in this research. For the coefficient of lateral earth pressure, the boundary of loosened ellipsoid is divided into two parts, the arch zone and the excavation zone, and the lateral pressure coefficients are derived respectively according to the stress state. For loosened earth pressure on tunnel, the Terzaghi earth pressure theory and Protodyakonov earth pressure theory are adapted in different conditions according to the state of loosened cobble soil. Theories developed in this study can be applied on determination of shield excavation parameters, as well as calculation of loosened earth pressure and control of tunnel support.

Keywords: sandy cobble soil; lagged settlement; loosened earth pressure; coefficient of lateral earth pressure; ellipsoid theory of particle flows

1. Introduction

Sandy cobble soils are mainly composed of cobbles, gravels, sand and some clayey soil, the structure of sandy cobble soil is discrete and easy to be disturbed. Different from other soils and rocks, the mechanical properties of cobble soil are rather complex, shield construction in this kind of stratum may cause land subsidence and collapse easily [1,2]. For all land settlement accidents in cobble soil layer, the most typical one is lagged settlement. If the thrust of TBM (Tunnel Boring Machine) is insufficient, it is easy to cause over excavation and form a soil cavity, with the cavity moving to the ground, lagged settlement will happen.

The lagged settlement (or delayed settlement) in sandy cobble soil is related to its mechanical properties. Under natural conditions, sandy cobble soil has a slight of initial cohesion, and cobbles usually interlock together forming a skeleton structure. But once disturbed, it will lose the initial cohesion and change into a loose structure [3]. During shield construction, when over excavation happens the land subsidence will not happen immediately, instead, a cavity will form in disturbed zone, the undisturbed soil above the cavity will be stable for a long time due to the arching effect. However, under the vibration of ground vehicles, the self-stability will fail and the cavity will eventually move to ground surface resulting in land subsidence or collapse. This process usually lasts for months, sometimes even years and that is why we call it lagged settlement. At present, there are many investigations on the process and mechanism of lagged settlement in sandy cobble soils [4–7], but the research of stress distribution in disturbed zone and evolution of earth pressure on shield tunnel is still insufficient.

In terms of earth pressure theories, the simplest is the full earth pressure theory, i.e. the pressure on tunnel is the weight of overlying soil column. In fact, due to the soil arching effect, earth pressure on tunnel is usually smaller than the weight of the overlying soil. The earliest experimental study on tunnel earth pressure was conducted by Terzaghi [8]. Terzaghi [8,9] designed a trap-door experiment on sand which confirmed the existence of soil arching effect. He thinks that the soil arching effect was caused by the uneven displacement of soil and derived the calculation formula. Terzaghi's theory has been widely used in the calculation of earth pressure on the mined tunnel [8]. However, shield tunnel is quite different from traditional mining method. In addition, Terzaghi formula is not suitable for sandy cobble soil due to the special properties of this stratum. M. M. Protodyakonov proposed another earth pressure theory which is often named as Po's arch theory [10]. Protodyakonov assumes that there is a intact arch area above the tunnel which separates the disturbed zone from surrounding stratum, the pressure on tunnel is the weight of soil within the arch area. Actually, the morphology of disturbed zone in sandy cobble soil is quite different from that in Protodyakonov's theory. Besides, the application condition of Protodyakonov's theory is rather strict, its basic assumptions are quite different from the actual state of sandy cobble soil. Jun Wu [11], Quanmei Gong [12] et al. believe that the disturbed zone is a limited ellipsoid, in sand layers, with the outflow of soil particles from trap-door, the loosened area will gradually expand to the limit ellipsoid whereas the soil outside the ellipsoid are in static state [13]. Ellipsoid theory of particle flows has been successfully applied on sandy stratum, but it still needs effort to apply on sandy cobble stratum since the self-stability of cobble soil is much better. Besides, in different phases of lagged settlement, the stress distribution in disturbed zone and earth pressure on tunnel are different and they need to be analyzed respectively.

This paper aims to investigate the stress distribution characteristics in loosened sandy cobble stratum, which is related to the stability of soil stratum and mechanical control of shield excavation.

In this paper, the process and mechanism of lagged settlement or collapse in sandy cobble stratum were analyzed. Based on ellipsoid theory of particle flows, the coefficient of lateral earth pressure in loosened zone is derived. For the earth pressure on tunnel, the evolution of lagged settlement in different phases including soil disturbance, formation of cavity, cavity moving upward and land subsidence are analyzed, and theoretical formulas of loosened earth pressure are derived respectively. Results are helpful for understanding the stress distribution in disturbed cobble soil, providing theoretical guidance for control of shield thrust and calculation of tunnel support.

2. Classical earth pressure theories for underground tunnels

2.1. Full earth pressure theory

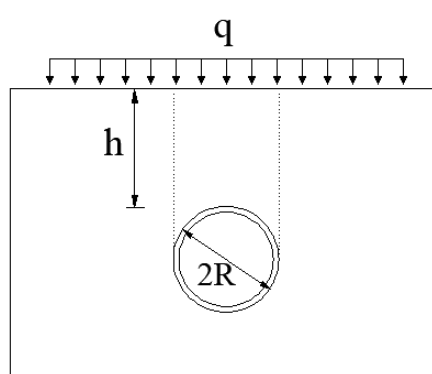

Figure 1. Schematic diagram of full earth pressure theory.

Full earth pressure theory is the simplest theory for earth pressure calculation. As shown in Figure 1, if the tunnel is shallow or the soil is soft, it can be approximately considered that the earth pressure on the tunnel is the weight of soil within the width of the tunnel. Considering the effect of external load, theoretical formula for calculating earth pressure can be expressed as:

$$\sigma_z = \gamma \cdot h + q \quad (1)$$

where γ is unit weight of soil.

Full earth pressure theory is effective when tunnel is shallow and the soil is soft. However, it has not taken into consideration of the shear action of soil and the arching effect.

2.2. M. M. Protodyakonov earth pressure theory

M. M. Protodyakonov (Михаил Михайлович Протодьяконов) [14] assumed that after excavation, a naturally balanced arch will form above the tunnel, and two sliding surfaces will form at both sides of the tunnel. Due to the arching effect, soil outside the arch does not exert pressure on the tunnel, and earth pressure on the tunnel is the weight of the soil within the arch. Regarding the morphology of the soil arch, Protodyakonov deduced that the morphology of the arch curve is a

parabola.

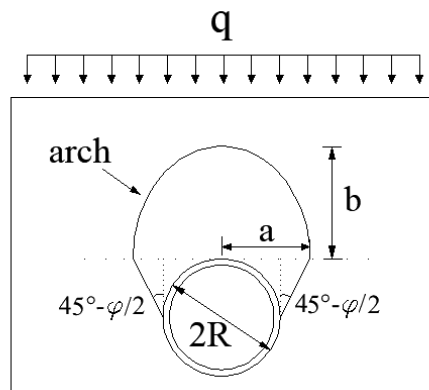

Figure 2. Schematic diagram of Protodyakonov earth pressure theory.

As shown in Figure 2, the parameters of the arch can be expressed as follows

$$a = R + R \tan\left(45^\circ - \frac{\phi}{2}\right) \quad (2)$$

$$b = \frac{a}{f} \quad (3)$$

where f is coefficient of rock solidity.

The earth pressure on the tunnel is

$$\sigma_z = \gamma b = \frac{\gamma a}{f} \quad (4)$$

The Protodyakonov arch theory takes into consideration of soil arching effect, but its application scope is relatively small, because different rocks usually have different properties. In addition, it is difficult to form a complete arch in many soils and the morphology of arches in different soils are also difficult to determine.

2.3. Terzaghi earth pressure theory

Terzaghi [9,15] designed and conducted a trap-door experiment as shown in Figure 3a. According to the experiment result, the sliding boundary is a curved surface and the width of sliding zone will decrease with the increase of depth. By simplifying the calculation model, he derived the analytical formula of vertical stress on trap-door.

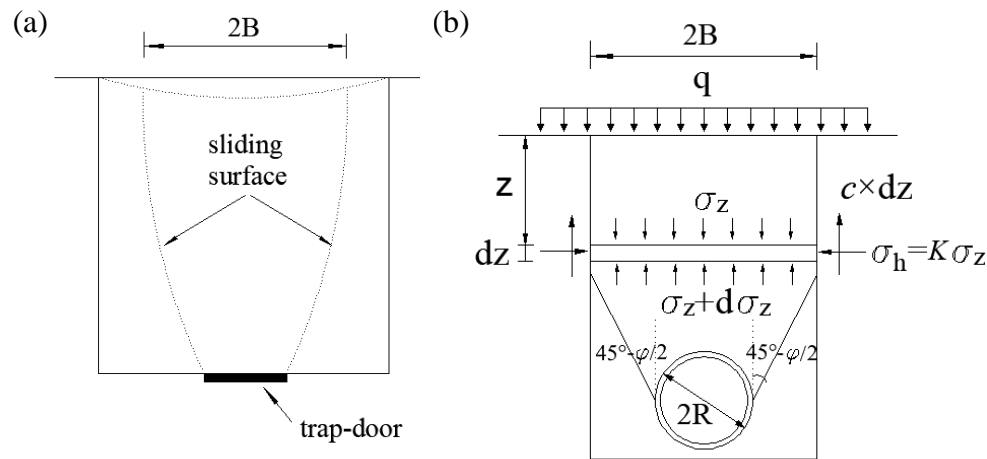

Figure 3. (a) Trap-door experiment. (b) Schematic diagram of Terzaghi earth pressure theory.

Figure 3b is a simplified calculation model for earth pressure on tunnel. Assuming that within a certain width, the soil column tends to move downward due to the tunnel deformation. According to the balance of vertical stresses, the equilibrium equation of the soil unit can be expressed as

$$2B\sigma_z + 2B\gamma dz = 2B(\sigma_z + d\sigma_z) + 2cdz + 2K\sigma_z dz \cdot \tan \varphi \quad (5)$$

where γ is unit weight of soil, c , φ are cohesion and internal friction angle of soil respectively, K is the lateral pressure coefficient of soil, $2B$ is the width of sliding soil, and

$$2B = 2R + 2R \left[\tan \left(45^\circ - \frac{\varphi}{2} \right) \right] \quad (6)$$

According to the boundary condition of $z = 0, \sigma_z = q$, the earth pressure at depth z can be expressed as

$$\sigma_z = \frac{B\gamma - c}{K \tan \varphi} \left(1 - e^{-\frac{K \tan \varphi \cdot z}{B}} \right) + qe^{-\frac{K \tan \varphi \cdot z}{B}} \quad (7)$$

It is not difficult to find that, in this theory, the sliding surface of soil column is related to the active earth pressure. As an extension of full earth pressure theory, Terzaghi considered the effect of soil cohesion and friction. We can conclude from the basic assumption that, the application condition of this theory is the soil column has a tendency to move downward, or the boundary condition of the sliding zone is at the critical equilibrium state.

Terzaghi formula is also a simplified method since the sliding boundary was simplified by a broken line and the upper part is simplified to vertical surface. In addition, the arching effect in soil is not considered in Terzaghi formula. This theory is more accurate for the earth pressure on pipeline buried in trench.

3. Lagged settlement in sandy cobble strata and ellipsoid theory of particle flows

3.1. Mechanism and morphological characteristics of lagged subsidence in sandy cobble strata

The mechanism of lagged settlement in sandy cobble strata has been proposed by several researchers. According to Yingchao Jiang [16,17] and Yongxue Bai [1,18], there are four phases throughout the evolution of lagged settlement, including instability of excavation face, over excavation and formation of cavity, cavity moving upward, land collapse. Cavities are usually on right top of the tunnel because of disturbance, gravity and over excavation. For cobble soil outside the disturbed zone, the structure is relatively stable and the arching effect can maintain the cavity for a long time if no extra disturbance exists. As time going on, many factors will break the balance of arch, such as the change of groundwater level, creep of soil and disturbance from traffic load. Under the action of gravity and disturbance, the soil on top of the cavity keeps falling off and the cavity will gradually move upward, finally the cavity develops to the surface leading to a sudden collapse.

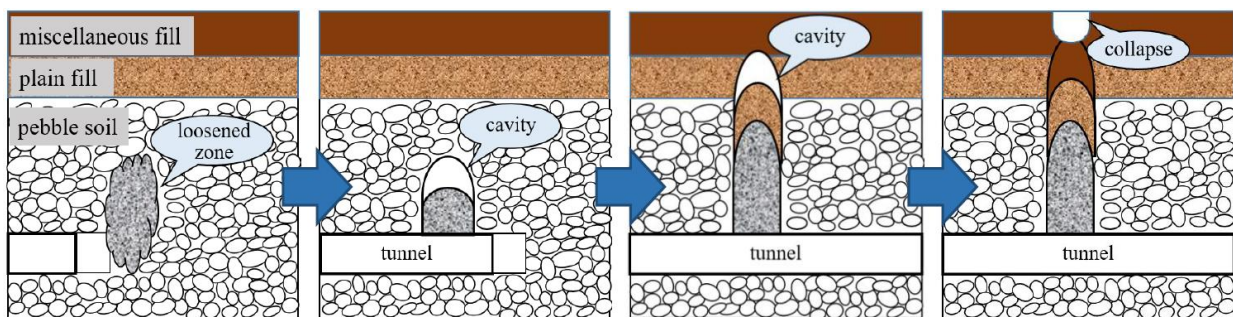

Figure 4. Evolution law of lagged settlement in sandy cobble strata (adapted from [16]).

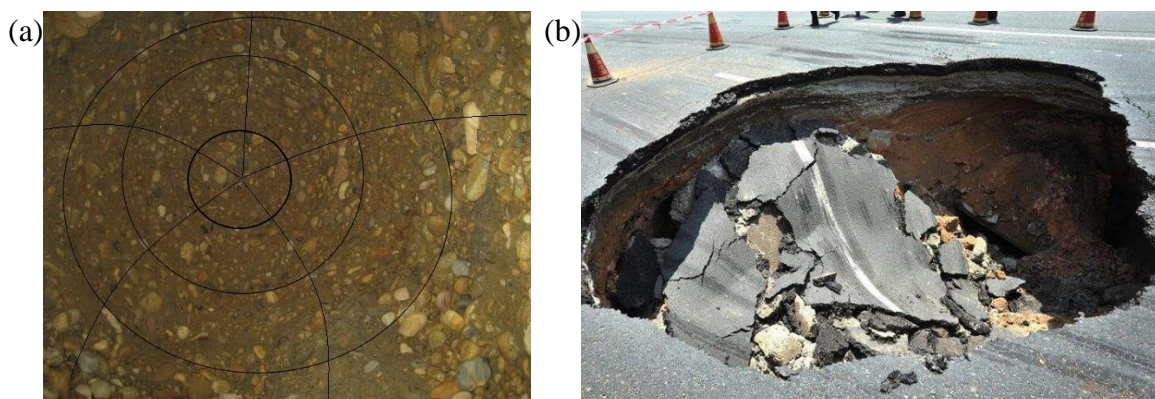

Figure 5. (a) Cavity caused by shield construction in sandy cobble strata (upward view, adapted from [1]). (b) Pavement collapse.

Figure 4 illustrates the evolution process of lagged settlement. Firstly, under the disturbance of TBM, a loosened zone appears in front of the tunnel face. Then, under the action of gravity and excavation, loosened cobble soil pours into the cutter head leading to over excavation and formation of a cavity in cobble stratum. Thirdly, under the action of external disturbance, the cavity gradually

moves upward and eventually leads to a land collapse. Figure 5a is internal view of the cavity, black lines show the outline of the cavity. Figure 5b is a typical pavement collapse in sandy cobble strata induced by shield construction. Both theoretical research and engineering practice show that, in cobble soil strata, the loosened zone and cavity caused by shield tunneling are mostly elliptically shaped.

3.2. Ellipsoid theory of particle flows

Ellipsoid theory of particle flows was proposed by Malakhov (Г. Малахов) in 1952 [12,19], and the theory was applied in mining and metallurgy at first. Janelid et.al. [20,21] divided the ellipsoid into two parts according to the moving state of inside particles, i.e., the loosened ellipsoid and the outflow ellipsoid, and he proposed the concept of loosening coefficient to describe the relationship between them.

As shown in Figure 6a, Ellipsoid theory of particle flows assumes that there is a bunker filled with mineral particles and there is a tapping hole at the bottom, when the tapping hole opens, the particles will flow out through it. In a steady state of outflow, the particles will flow out from a zone named outflow ellipsoid. Correspondingly, there is a loosened ellipsoid (or limit ellipsoid) in a certain range outside the outflow ellipsoid. Based on the boundaries of outflow ellipsoid and loosened ellipsoid, the particles in the bunker can be divided into three parts, within the outflow ellipsoid is the outflow zone, between outflow ellipsoid and limit ellipsoid is the loosened zone, particles outside the limit ellipsoid is the static zone.

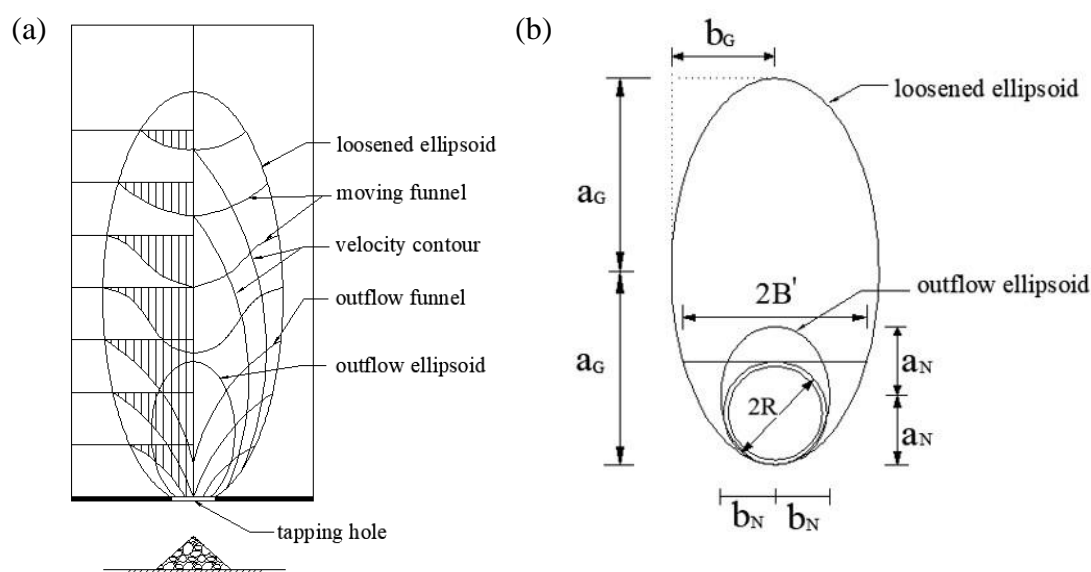

Figure 6. (a) Ellipsoid theory of particle flows applied in ore drawing (adapted from [22]). (b) Adapted model for shield construction in sandy cobble soil.

Figure 6b is a diagram of ellipsoid theory adapted for shield construction in sandy cobble soil. Different from ore drawing theory, the position of tapping hole is the cutter head of TBM (or the section of the tunnel). In Figure 6b, we can get some dimension parameters about loosened ellipsoid and outflow ellipsoid. Assuming that the long axis and short axis of outflow ellipsoid are a_N and

b_N respectively. Similarly, a_G and b_G for limit ellipsoid.

The eccentricity of the outflow ellipsoid can be expressed as formula 8, and in practice, the value of ε is 0.90–0.98 [23].

$$\varepsilon = \left(1 - b_N^2 / a_N^2\right)^{1/2} \quad (8)$$

Assuming that the volume of outflow ellipsoid and loosened ellipsoid are E_N and E_G respectively. According to [24], the loosening coefficient in limit ellipsoid will be

$$\beta = \frac{E_G}{E_G - E_N} \quad (9)$$

where β is a constant within 1.066–1.100 [11,12].

In Figure 6b, the outflow of particles is concentrated in the face of TBM, so the area of outflow ellipsoid can be assumed to be the area of tunnel section. Namely

$$\pi a_N b_N = \pi R^2 \quad (10)$$

By calculation of equation 8 and 10, we can get

$$a_N = R(1 - \varepsilon^2)^{-1/4} \quad (11)$$

$$b_N = R(1 - \varepsilon^2)^{1/4} \quad (12)$$

Similarly, by calculating simultaneous equation 8 to 12, the long axis and short axis of loosened ellipsoid are

$$a_G = R \left(\frac{\beta}{\beta - 1} \right)^{1/2} (1 - \varepsilon^2)^{-1/4} \quad (13)$$

$$b_G = R \left(\frac{\beta}{\beta - 1} \right)^{1/2} (1 - \varepsilon^2)^{1/4} \quad (14)$$

Many investigation results show that, ellipsoid theory of particle flows is applicable for earth pressure analysis in sand stratum, because both soil arching effect and the characteristics of disturbed zone have been taken into account [11,12,19]. Here, by analyzing the characteristics of sandy cobble soil in section 3.1, it is not difficult to find that, the mechanism and process of lagged settlement in sandy cobble strata are consistent with the ellipsoid theory, and the morphology of the loosened zone is in good agreement with limit ellipsoid.

Based on ellipsoid theory of particle flows, this paper will analyze the coefficient of lateral earth

pressure in critical equilibrium state, and also derive the loosened earth pressure on tunnel in several states including the limit equilibrium state, the formation of cavity by over excavation, the upward moving of cavity.

4. Coefficient of lateral earth pressure on loosened ellipsoid

In this section, we will mainly discuss the pressure on boundary of the loosened ellipsoid, because cobble soil on the boundary is in the state of critical slip, i.e. the ‘critical stress state’ in soil mechanics. For cobble soil inside the ellipsoid, the stress states are more complicated since they keep moving at different speeds, and that is beyond the scope of our research. On the other hand, for soil outside the loosened ellipsoid, they are not disturbed and keep in a static state, the stress state can be analyzed through general method which is also not discussed in this paper.

The coefficient of lateral earth pressure is related to the stress state at different positions [8,25]. As will be discussed later, the critical state at different positions are caused by different factors, it is necessary to divide the ellipsoid into two parts, the arch zone and the excavation zone, here we simplify it as the upper and lower half ellipsoid.

4.1. Coefficient of lateral earth pressure in soil arch zone

The arch zone discussed here is the condition when the loosened zone extends to the critical state, i.e., the loosened zone has extended to the limit ellipsoid and the cavity has not formed yet. In fact, at beginning the disturbed zone is very small, with the gradual expansion, the disturbed zone will finally expand to the limit ellipsoid and reach the critical state [26]. In critical state, the arching effect will be very obvious on top of upper ellipsoid due to the skeleton structure of cobble soil. In this condition, the boundary curve of limit ellipsoid can be considered as the arch axis. For the distribution of stress, it can be assumed that the major principal stress is distributed along the arch axis, which has been proposed in many studies [8,27–29].

In order to analyze the lateral earth pressure on boundary element, we pick a point on the upper half of the ellipsoid. As shown in Figure 7a, σ_1 and σ_3 are major and minor principal stress respectively. σ_h and σ_v are the horizontal stress and vertical stress at that point. τ' is the shear stress on the vertical surface. Assuming that the angle between σ_1 and σ_h is θ and the internal friction angle of sandy cobble soil is φ . Then the stress state of boundary element at this point can be described by a Mohr circle in Figure 7b.

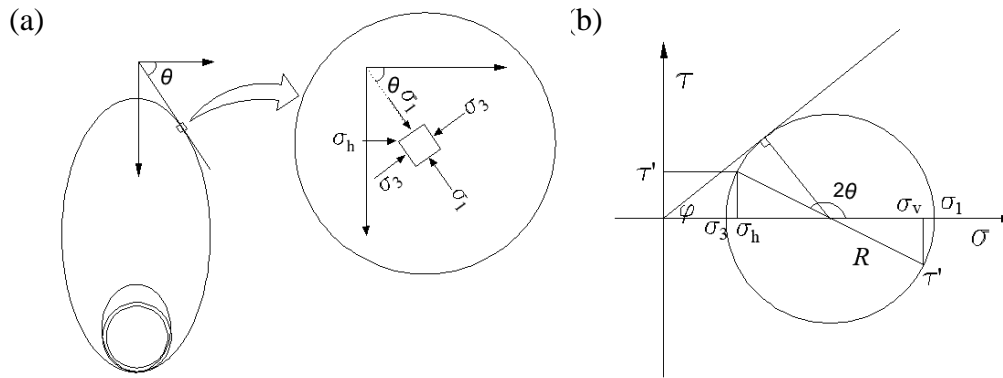

Figure 7. Schematic diagram of lateral pressure coefficient on arch zone (upper half ellipse). (a) Stress state of boundary element. (b) Mohr circle of soil stress.

The following results can be obtained from the Mohr circle:

$$R = \frac{\sigma_1 - \sigma_3}{2} \quad (15)$$

$$\sigma_h = \frac{\sigma_1 + \sigma_3}{2} - R \cos(180 - 2\theta) \quad (16)$$

$$\sigma_v = \frac{\sigma_1 + \sigma_3}{2} + R \cos(180 - 2\theta) \quad (17)$$

Substituting equation 15 back to 16 and 17 then results

$$\sigma_h = \sigma_1 \cos^2 \theta + \sigma_3 \sin^2 \theta \quad (18)$$

$$\sigma_v = \sigma_1 \sin^2 \theta + \sigma_3 \cos^2 \theta \quad (19)$$

Equation 18 divided by equation 19, then result

$$\frac{\sigma_h}{\sigma_v} = \frac{\sigma_1 \cos^2 \theta + \sigma_3 \sin^2 \theta}{\sigma_1 \sin^2 \theta + \sigma_3 \cos^2 \theta} \quad (20)$$

Divide numerator and denominator by $\sigma_1 \cos^2 \theta$ simultaneously, then

$$\frac{\sigma_h}{\sigma_v} = \frac{1 + \frac{\sigma_3}{\sigma_1} \tan^2 \theta}{\tan^2 \theta + \frac{\sigma_3}{\sigma_1}} \quad (21)$$

As we can see from Figure 7b

$$\sin \varphi = \frac{(\sigma_1 - \sigma_3) / 2}{(\sigma_1 + \sigma_3) / 2} \quad (22)$$

By transformation, it is

$$\frac{\sigma_3}{\sigma_1} = \frac{1 - \sin \varphi}{1 + \sin \varphi} = \tan^2(45 - \varphi / 2) = K_a \quad (23)$$

Substituting equation 23 back to 21 then result

$$K = \frac{\sigma_h}{\sigma_v} = \frac{1 + K_a \tan^2 \theta}{\tan^2 \theta + K_a} \quad (24)$$

It can be seen from formula 24 that, the coefficient of lateral earth pressure on ellipsoid boundary is a function of θ , which is related to the position of the arch. Particularly, at the short axis of the ellipse ($\theta = 90^\circ$), K will be K_a (which can be deduced from equation 23). This means when $\theta = 90^\circ$, cobble soil is in an active earth pressure state, this is consistent with the theory of soil mechanics. For another particular position, the vault ($\theta = 0^\circ$), that will be $K = \frac{1}{K_a} = K_p$, which

means soil at this point is in a passive earth pressure state.

For different cobble soils, the range and morphology of loosened ellipsoid are slightly different, which is related to the properties of soils such as particle size distribution, water content, cohesion and internal friction angle. Besides, the extent of soil arching effect also plays an important role. Before extending to limit ellipsoid, the soil arch is called 'incomplete arch'. For incomplete arch, the vault is difficult to determine and the major principal stress does not necessarily distribute along the arch axis, as a result, the formula 24 will be not very accurate.

4.2. Coefficient of lateral earth pressure in excavation zone

Different from the arch zone in section 4.1, the formation of sliding surface in excavation zone is not due to gravity. Although it is also related to the mechanical disturbance, the main reason is the thrust of shield machine. To simplify the derivation process, we assume that the excavation zone is the lower half ellipsoid. For excavation zone, there is no arching effect on the sliding surface, so the principal stress is no longer distributed along the curve of sliding surface. In this condition, the shear stress on boundary element reaches the critical state under the action of shield excavation, which leads to a shear failure on the sliding surface, as shown in Figure 8. Based on the theory of loosened ellipsoid, we assume that the morphology of sliding surface is also ellipsoid.

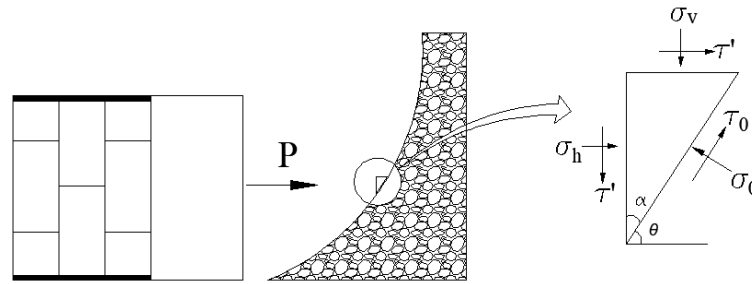

Figure 8. Schematic diagram of stress state on excavation zone (lower half ellipse).

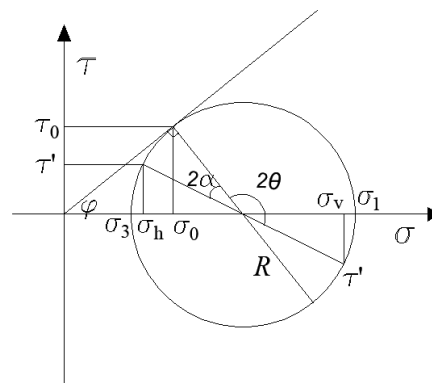

Figure 9. Mohr circle of soil stress on boundary element.

Under the action of thrust and excavation from TBM, the stress state of boundary element on loosened ellipsoid can be illustrated in Figure 8 and the Mohr circle can be represented as Figure 9. Assuming that the angle between horizontal plane and the tangent to boundary element is θ , the angle between vertical plane and the tangent will be $\alpha=90^\circ-\theta$, on the Mohr circle they are 2θ and 2α respectively.

It can be obtained from the Mohr circle that:

$$2\alpha=180^\circ-2\theta \quad (25)$$

$$\sigma_h = \frac{R}{\sin \varphi} - R \cos(90^\circ - \varphi - 2\alpha) = \frac{R}{\sin \varphi} - R \sin(\varphi + 2\theta) \quad (26)$$

$$\sigma_v = \frac{R}{\sin \varphi} + R \cos(90^\circ - \varphi - 2\alpha) = \frac{R}{\sin \varphi} + R \sin(\varphi + 2\theta) \quad (27)$$

Eq 26 divided by Eq 27, then result

$$K = \frac{\sigma_h}{\sigma_v} = \frac{\frac{R}{\sin \varphi} - R \sin(\varphi + 2\theta)}{\frac{R}{\sin \varphi} + R \sin(\varphi + 2\theta)} \quad (28)$$

By transformation, it is

$$K = \frac{1 - \sin(2\theta - \varphi) \sin \varphi}{1 + \sin(2\theta - \varphi) \sin \varphi} \quad (29)$$

Formula 29 is the coefficient of lateral earth pressure in excavation zone, as we can see it is a function of θ and φ and it has nothing to do with the depth of the tunnel. It can be explained that the disturbed zone is limited in the range of loosened ellipsoid, soils outside this zone remain static in a equilibrium state and exert no influence. Similar result was reported by Quanmei Gong in reference [12]. Particularly, if $\theta=90^\circ$ then $K = \frac{1 - \sin^2 \varphi}{1 + \sin^2 \varphi}$, it is a value less than 1, because at the short axes, the vertical stress (which originates from the unloading of excavation below) is a dominant factor which leads to the critical state. As a result, the vertical stress will be greater than horizontal stress. On the contrary, if $\theta=0^\circ$ then $K = \frac{1 + \sin^2 \varphi}{1 - \sin^2 \varphi}$, here $K > 1$ because at the bottom of the ellipsoid, the critical state of cobble soil is caused by the thrust action of TBM and the horizontal stress will be greater than that on vertical.

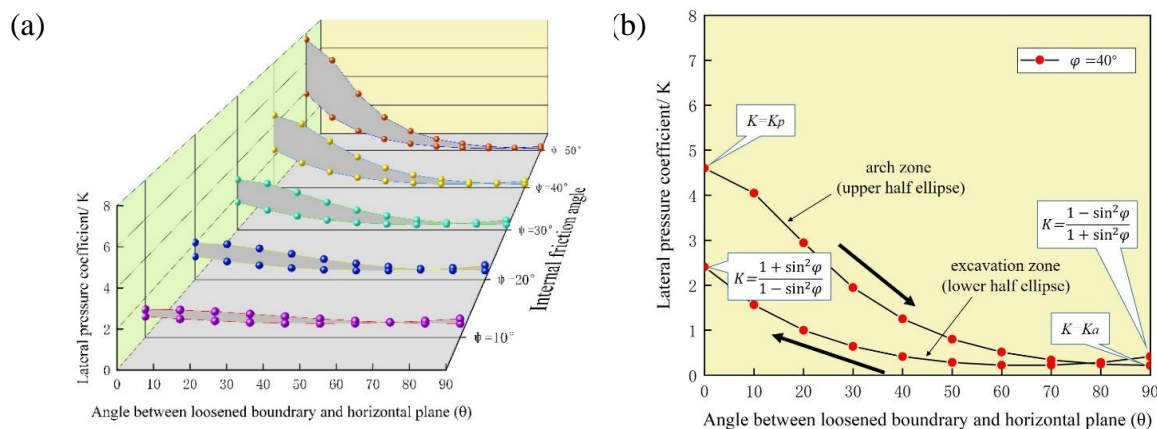

Figure 10. (a) Coefficient of lateral earth pressure / $\varphi=10^\circ\sim 50^\circ$. (b) Coefficient of lateral earth pressure / $\varphi=40^\circ$.

Figure 10a illustrates the variation of lateral earth pressure coefficients on the loosened ellipsoid when $\varphi=10^{\circ}\sim 50^{\circ}$, where φ is the internal friction angle of sandy cobble soil. Figure 10b highlights the variation of lateral earth pressure coefficients when $\varphi=40^{\circ}$. It can be found that the coefficient of arch zone is larger than that of excavation zone, which can be explained by the full exertion of arching effect. Besides, when θ is close to 90° the coefficients of lateral earth pressure in two different zones gradually coincide, in fact this position is the intersection of arch zone and excavation zone. When $\theta=90^{\circ}$, the coefficients calculated by two methods are slightly different, because the assumptions of stress states in two conditions are different, but in fact the calculation results are very close.

5. Loosened earth pressure based on ellipsoid theory of particle flows

Through the analysis in chapter 3, it can be seen that the disturbed zone originates from the excavation face and then gradually extends to the limit ellipsoid, with the cavity gradually moves to ground surface the land collapse occurs. During this process only soil inside the loosened ellipsoid exerts pressure on tunnel, whereas the soils outside the loosened zone remain in a static state due to the soil arching effect. As a result, the pressure on tunnel will mainly come from the soil in the loosened area, and will be in constant change with the expansion of the loosened zone and movement of the cavity. In this chapter, the loosened earth pressure in sandy cobble soil under three typical states will be derived respectively. Here the Terzaghi formula is adapted and the Protodyakonov's theory of soil arch is also taken into account.

5.1. Vertical earth pressure in limit state

Limit state is the condition when loosened zone expands to limit ellipsoid and the cavity has not formed yet. As shown in Figure 11a, if the tunnel is a deep-buried tunnel, the limit ellipsoid will be beneath the ground. In this condition, the external load has no influence on the tunnel because of the arching effect. In figure 11b, the area of $ABCD$ is selected as the soil column, where AB is tangent to the top of the tunnel and CD is tangent to the top of the limit ellipse. It should be pointed out that for safety consideration, the width of soil column in arch zone is assumed equal to the bottom. i.e. $CD = AB$. On the other hand, in most conditions the soil arch manifests as incomplete arch, and the boundary of arch zone is not very distinct. For this assumption, the stress distribution in arch zone will be reflected on the calculation element as will be discussed later.

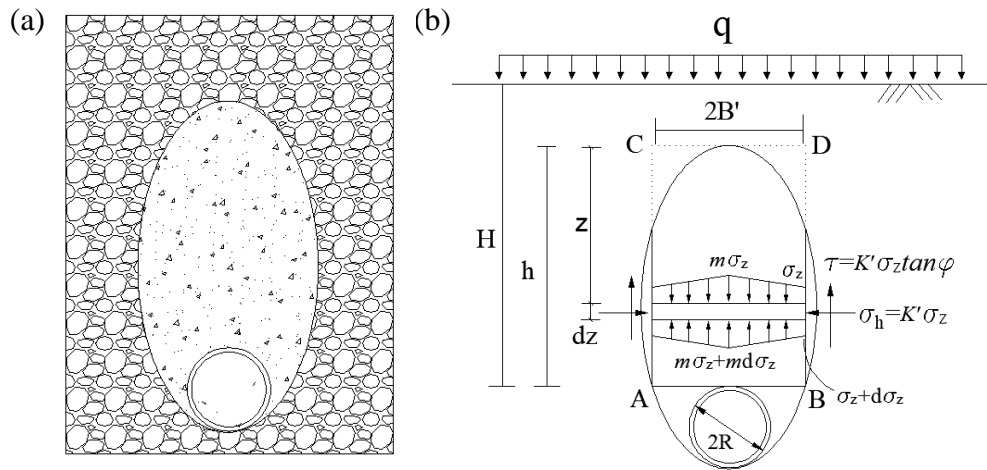

Figure 11. (a) Limit loosened ellipsoid. (b) Schematic diagram of loosened earth pressure.

In Figure 11b, the width of soil column, i.e. the length of AB can be expressed as

$$2B' = 4\sqrt{(1-\varepsilon^2)(a_G - R)R} \quad (30)$$

For the stress distribution on the calculation element, since the earth pressure mainly comes from the weight of soil in the loosened ellipsoid, the stress on right top of tunnel will be greater than that on both sides. Assuming that the earth pressure on the middle line is m times of that on both sides ($m > 1$). For element in Figure 11b the equilibrium equation of vertical stress is

$$B'(\sigma_z + m\sigma_z) + 2B'\gamma' dz = B'(\sigma_z + d\sigma_z + m\sigma_z + md\sigma_z) + 2K'\sigma_z \tan \phi dz \quad (31)$$

where γ' is the unit weight of loose soil, K' is lateral pressure coefficient on the vertical surface.

It can be obtained after conversion that

$$\frac{B'(1+m)d\sigma_z}{2B'\gamma' - 2K'\tan \phi \sigma_z} = dz \quad (32)$$

Integrate the two sides of Eq 32, then

$$-\frac{B'(1+m)}{2K'\tan \phi} \ln(2B'\gamma' - 2K'\tan \phi \sigma_z) = z + C_1 \quad (33)$$

Taking boundary conditions $z = 0, \sigma_z = 0$ into Eq 33, then

$$C_1 = -\frac{B'(1+m)\ln(2B'\gamma')}{2K'\tan \phi} \quad (34)$$

Assuming $Q = -\frac{B'(1+m)}{2K'\tan\varphi}$, then Eq 34 will be

$$C_1 = Q \ln(2B'\gamma') \quad (35)$$

And Eq 33 will be

$$Q \ln(2B'\gamma' - 2K'\tan\varphi\sigma_z) = z + C_1 \quad (36)$$

It can be obtained after conversion

$$\sigma_z = \frac{B'\gamma'}{K'\tan\varphi} - \frac{1}{2K'\tan\varphi} e^{\frac{z+C_1}{Q}} \quad (37)$$

Combining Eqs 35 and 37, result is

$$\sigma_z = \frac{B'\gamma'}{K'\tan\varphi} - \frac{1}{2K'\tan\varphi} e^{\frac{z}{Q} + \ln(2B'\gamma')} = \frac{B'\gamma'}{K'\tan\varphi} - \frac{B'\gamma'}{K'\tan\varphi} e^{\frac{z}{Q}} \quad (38)$$

Substituting $Q = -\frac{B'(1+m)}{2K'\tan\varphi}$ back into Eq 38 then result

$$\sigma_z = \frac{B'\gamma'}{K'\tan\varphi} \left(1 - e^{\frac{2K'\tan\varphi \cdot z}{B'(1+m)}} \right) \quad (39)$$

Formula 39 is the loosened earth pressure at different depth in the limit ellipsoid. Assuming that $z = h$, the earth pressure on top of the tunnel can be obtained from formula 39.

It should be noted that the lateral pressure coefficient K' here is different from that in section 4.

The K in section 4 refers to the points on the boundary of the loosened ellipsoid, while K' here refers to the lateral pressure coefficient on the vertical surface, i.e. the AC and BD sides. For the value of K' , Maston [30] suggested that the value can be taken as K_a . This is reasonable since the soil at the vertical surface is in active earth pressure state.

In this section we only discuss the condition when disturbed zone extends to limit ellipsoid, the previous periods (initial disturbance and expansion) are not discussed here, because they last for only a short time during excavation. Moreover, the constant changing state also makes it difficult to investigate.

5.2. Vertical earth pressure in over excavation state

Similar to section 5.1, if the tunnel is deep enough, land collapse will also not occur immediately in the state of over excavation. On the contrary, a cavity will form at the top of loosened ellipsoid (internal view is shown in Figure 5a). In this condition, the loosened zone is similar to a silo filled with loose particles (see Figure 12a) and the earth pressure on tunnel is only related to the gravity of loosened soil in it. As shown in Figure 12b, the effective soil column is the area of $ABCD$. Similar to section 5.1, the width of soil column ($2B'$) can also be expressed as formula 30, and the section of AB is taken as the calculation surface of earth pressure on tunnel.

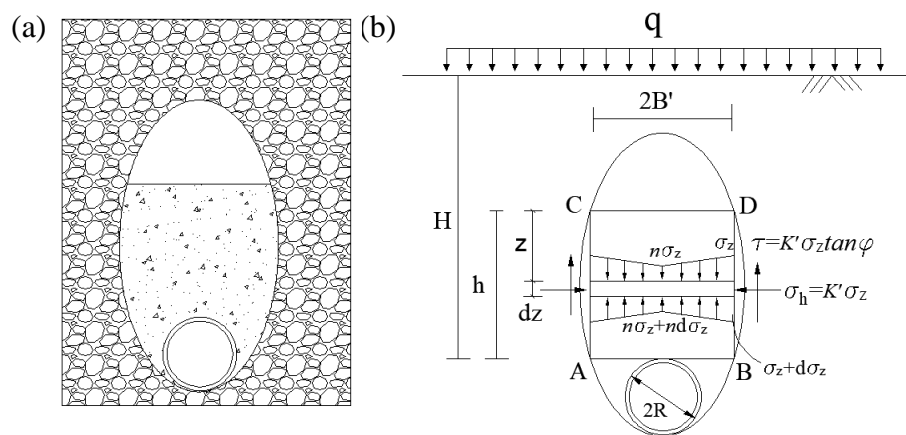

Figure 12. (a) Loosened zone and cavity in sandy cobble soil. (b) Schematic diagram of loosened earth pressure.

It should be noted that for calculation element, the distribution of vertical stress is contrary to limit state condition in section 5.1. As shown in Figure 12b, the stress on top of tunnel is smaller compared with two edges. This phenomenon can be explained by the trap-door experiment conducted by Terzaghi. As shown in Figure 13, when the trap-door opens the vertical stress on top of trap-door will decrease, and the major principal stress will move to both sides [12,31]. In this condition, the actual stress distribution is like Figure 13b.

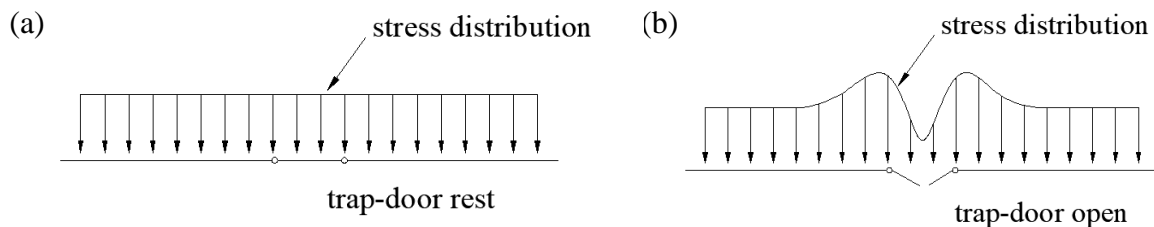

Figure 13. Stress distribution on trap-door. (a) Trap-door is at rest. (b) Trap-door is open. (adapted from [12]).

In this case, it can be assumed that the stress on the midline is n times that on both sides ($n < 1$

and $\frac{1}{n}=3.256\sim 3.745$ according to [11]). For the element in Figure 12b, the equilibrium equation of vertical stress can be expressed as

$$B'(\sigma_z + n\sigma_z) + 2B'\gamma' dz = B'(\sigma_z + d\sigma_z + n\sigma_z + nd\sigma_z) + 2K'\sigma_z \tan \varphi dz \quad (40)$$

It can be obtained after conversion:

$$\frac{B'(1+n)d\sigma_z}{2B'\gamma' - 2K'\tan \varphi \sigma_z} = dz \quad (41)$$

Similar to the calculation process in section 5.1, the earth pressure at different depth is

$$\sigma_z = \frac{B'\gamma'}{K'\tan \varphi} \left(1 - e^{-\frac{2K'\tan \varphi \cdot z}{B'(1+n)}} \right) \quad (42)$$

Formula 42 is the loosened earth pressure in over excavation state. Assuming that $z = h$, the earth pressure on top of the tunnel can be obtained. As for the coefficient of lateral earth pressure (K'), since the soil in the ellipsoid is loose and also in the active earth pressure state, the lateral pressure coefficient of K' is also K_a .

Here we will consider another condition. As shown in Figure 14, if the tunnel is shallow, the loosened ellipsoid will be partly above the ground and that is impossible. Obviously, in this condition the disturbed range is ground surface to top of the tunnel. In this condition, even though the arch zone no longer exists, the morphology of disturbed zone is still consistent with ellipsoid theory of particle flows. Besides, the earth pressure on tunnel will be affected by external loads.

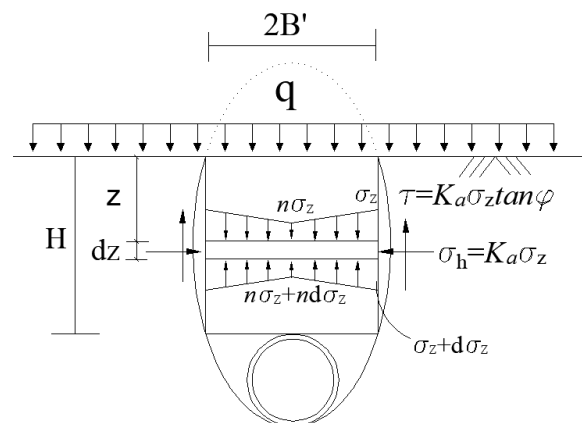

Figure 14. Schematic diagram of earth pressure on shallow shield tunnel.

The schematic diagram is shown in Figure 14. The equilibrium equation of the element can be expressed as

$$B'(\sigma_z + n\sigma_z) + 2B'\gamma' dz = B'(\sigma_z + d\sigma_z + n\sigma_z + nd\sigma_z) + 2K'\sigma_z \tan \varphi dz \quad (43)$$

Similar to the derivation process in section 5.1, the earth pressure at different depth is

$$\sigma_z = \frac{B'\gamma'}{K'\tan\varphi} \left(1 - e^{-\frac{2K'\tan\varphi \cdot z}{B'(1+n)}} \right) \quad (44)$$

Considering the influence of external load, the boundary condition of equation 44 will be $z = 0, \sigma_z = q$. Taking this boundary condition into equation 44, then result

$$\sigma_z = \frac{B'\gamma'}{K'\tan\varphi} \left(1 - e^{-\frac{2K'\tan\varphi \cdot z}{B'(1+n)}} \right) + qe^{-\frac{2K'\tan\varphi \cdot z}{B'(1+n)}} \quad (45)$$

Similarly, the coefficient of lateral earth pressure (K') is also K_a . Besides, the coefficient of stress distribution is also n , because it is a special condition of Figure 12, and the external load can be regarded as equivalent soil weight with a certain thickness.

5.3. Vertical earth pressure during upward moving of cavity

Before land collapse occurs, the cavity will gradually move upward under the action of external disturbance. Actually, before the cavity extends to ground, the loosened ellipsoid is still separated from external environment and the external load has no effect on the earth pressure, as shown in Figure 15.

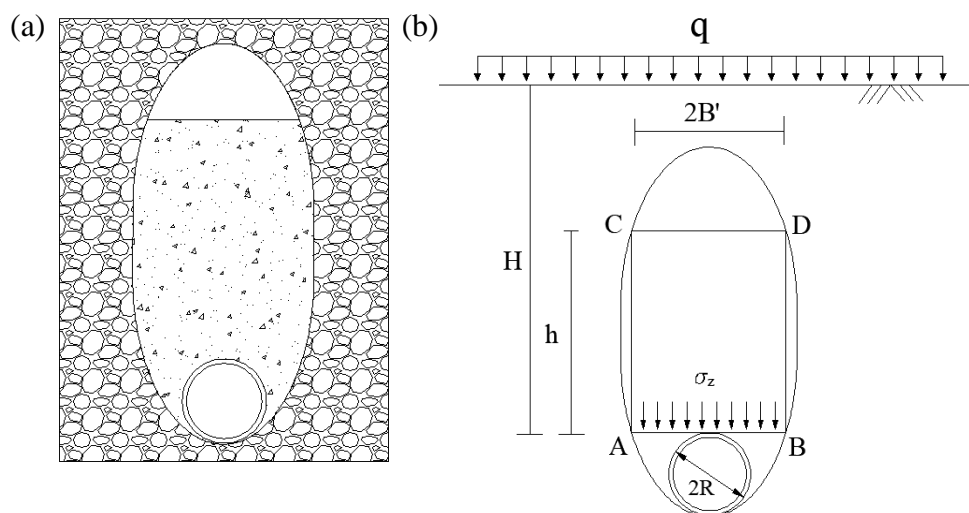

Figure 15. Schematic diagram of earth pressure during upward moving of cavity. (a) Upward moving of cavity in sandy cobble soil. (b) Loosened earth pressure on tunnel.

Generally speaking, in this condition the tunnel has already been supported and cobble soil no

longer flows out. As a result, the stress on the calculation surface will be uniformly distributed over time via stress redistribution. In this condition, if the tunnel has no obvious deformation, we can refer to Protodyakonov's theory in section 2.2, and the earth pressure on the tunnel is

$$\sigma_z = \gamma' h \quad (46)$$

In particular, if the tunnel deforms the earth pressure can be derived with formula 40-42.

6. Conclusion and outlook

Lagged settlement or collapse is a typical accident induced by shield excavation in sandy cobble soil, there are several phases throughout the evolution including disturbance in front of excavation face, over excavation, formation of cavity, cavity moves upward and ground collapse. The mechanism and process of lagged settlement in sandy cobble soil matches ellipsoid theory of particle flows well, based on this theory, the distribution of lateral earth pressure coefficient and earth pressure on tunnel are derived.

For coefficients of lateral earth pressure, the limit ellipsoid is divided into the arch zone and the excavation zone, and the formulas are derived respectively. Results show that the coefficient of lateral earth pressure is a function of the tangent angle of the boundary element, and the coefficient in arch zone is larger than that in excavation zone because of the soil arching effect.

For the loosened earth pressure on tunnel, three typical states are derived based on Terzaghi formula and Protodyakonov's theory. The first two cases are the limit ellipsoid state and over excavation state. For these two conditions, if the tunnel is deep-buried tunnel, loosened ellipsoid will be separated from surrounding soils due to the arching effect, and the pressure on tunnel depends on the weight of soil inside the ellipsoid. On the contrary, for shallow tunnel the pressure will be affected by external load. The third case is the cavity moving upward. For this case, if the tunnel does not deform, the earth pressure can be calculated by Protodyakonov's theory, otherwise the adapted Terzaghi formula will be more accurate.

Considering the insufficiencies in this paper, the following aspects still need more research. First of all, the ellipsoid theory of particle flows is an approximation in morphology, the actual state is related to the properties of cobble soils and degree of disturbance. Secondly, only typical states are covered in this paper, more details about stress distribution and deformation of cobble soil still need more research. Finally, for incomplete arch the major principal stress does not necessarily distribute along the arch axis, and the accuracy of the formula needs to be verified.

Acknowledgments

This work has been supported by Guangzhou Municipal Science and Technology Bureau (201904010290), the authors gratefully acknowledge this funding support. Besides, the authors would like to express their sincere thanks to anonymous referees for their valuable comments and suggestions.

Conflict of interest

All authors declare no conflict of interest in this paper.

References

1. Y. X. Bai, Research on ground collapse mechanism of shield tunnelling in saturated sandy pebble stratum and corresponding measures, Southwest Jiaotong University, 2012.
2. J. Z. Huang and G. Y. Xu, Study on the constitutive model of sandy pebble soil, Proceedings of China-Europe Conference on Geotechnical Engineering, Springer, Cham, (2018), 26–30.
3. J. Z. Huang, G. Y. Xu, Y. Wang, et al., Equivalent deformation modulus of sandy pebble soil—Mathematical derivation and numerical simulation. *Math. Biosci. Eng.*, **16** (2019), 2756–2774.
4. M. Hu, Numerical method to study the physical and mechanical characteristics of sandy pebble soil and the response caused by shield tunneling, South China University of Technology, 2014.
5. C. He, Y. C. Jiang, Y. Fang, et al., Impact of shield tunneling on adjacent pile foundation in sandy cobble strata. *Adv. Struct. Eng.* **8** (2013), 1457–1467.
6. C. He, K. Feng and Y. Fang, Surface settlement caused by twin-parallel shield tunnelling in sandy cobble strata, *J. Zhejiang Univ.-SCIA*, **11** (2012), 858–869.
7. M. N. Wang, L. H. Wei, J. F. Lu, et al., Study of face stability of cobble-soil shield tunnelling at Chengdu metro, *Rock Soil Mech.*, **1** (2011), 99–105.
8. C. L. Li, Method for calculating loosening earth pressure during construction of shield tunnels, *Chin. J. Geotech. Eng.*, **9** (2014), 1714–1720.
9. K. Terzaghi, Stress distribution in dry and in saturated sand above a yielding trap-door, Proceedings of First International Conference on Soil Mechanics and Foundation Engineering. Cambridge, Massachusetts, (1936), 307–311.
10. S. Z. Chen and C. X. Xu, Analysis and consideration of two ground pressure theories, *Hydraulic Sci. Technol.*, **3** (2001), 22–24.
11. J. Wu, S. M. Liao and D. Zhang, Loosening zone and earth pressure around tunnels in sandy soils based on ellipsoid theory of particle flows, *Chin. J. Geotech. Eng.*, **35** (2013), 714–721.
12. Q. M. Gong, R. L. Zhang, S. H. Zhou, et al., Method for calculating loosening earth pressure around tunnels based on ellipsoid theory of particle flows, *Chin. J. Geotech. Eng.*, **39** (2017), 99–105.
13. R. L. Handy, The arch in soil arching. *J. Geotech. Eng.*, **111** (1985), 302–317.
14. Y. R. Zheng and C. Y. Qiu, On the limitations of Protodyakonov's pressure arch theory, *Mod. Tunnel Technol.*, **53** (2016), 1–8.
15. K. Terzaghi, Theoretical soil mechanics, New York: Wiley, 1943.
16. Y. C. Jiang, Y. Fang, C. He, et al., Study on delayed settlement formation induced by shield tunneling in sandy cobble strata, *Chin. J. Undergr. Space Eng.*, **11** (2015), 171–177+265.
17. Y. C. Jiang, Study on the soil disturbance mechanism of shield tunnelling in sandy cobble stratum, Southwest Jiaotong University, 2014.
18. Y. X. Bai, T. Y. Qi, Y. D. Li, et al., Prediction for surface collapse deformation of shield construction based on LSSVM, *Chin. J. Rock Mech. Eng.*, **32** (2013), 3666–3674.
19. J. Du, Z. R. Mei and Y. Z. Chen, Study of failure calculation of tunnel face based on drawing ellipsoid theory, *Tunnel Constr.*, **38** (2018), 1497–1504.
20. B. H. Brady and E. T. Brown, Rock mechanics for underground mining, 3rd ed. New York: Kluwer Academic Publishers, (2005), 454–463.

21. B. H. Brady and E. T. Brown, *Rock mechanics: for underground mining*. Springer science & business media, 2013
22. J. P. Guo, D. Liu and R. F. Li, Reconstruction of moving transition equation for ellipsoid drawing theory, *Met. Min.*, **10** (2015), 37–40.
23. R. Kvapil, Sublevel caving. SME mining engineering handbook, 2nd ed. *New York: Soc. Min. Engrs., AIME*, (1992), 1789–1814.
24. R. F. Li, Several main problems of ellipsoid drawing theory: The necessity of establishing quasi-ellipsoid drawing theory, *China Molybdenum Industry*, **5** (1994), 39–43.
25. J. P. Giroud, R. Bonaparte, J. F. Beech, et al., Design of soil layer-geosynthetic systems overlying voids, *Geotext. Geomembr.*, **9** (1990), 11–50.
26. W. Zhu, X. C. Zhong and R. Jia, Simulation on relaxation effect of vertical earth pressure for shield tunnels by particle flow code, *Chin. J. Geotech. Eng.*, **30** (2008), 750–754.
27. C. J. Lee, K. H. Chiang, C. M. Kuo, Ground movement and tunnel stability when tunneling in sand ground, *J. Chin. Inst. Eng.*, **27** (2004), 1021–1032.
28. P. J. Lou and Y. Xu, Discussion on Method for calculating loosening earth pressure during construction of shield tunnels, *Chin. J. Geotech. Eng.*, **37** (2015), 1353–1354.
29. C. L. Li, Reply to discussion on Method for calculating loosening earth pressure during construction of shield tunnels, *Chin. J. Geotech. Eng.*, **37** (2015), 1355–1356.
30. A. Marston, *The theory of external loads on closed conduits in the light of the latest experiments*, Iowa: Iowa Engineering Experiment Station, 1930.
31. R. X. Chen, B. Zhu, Y. M. Chen, et al., Modified Terzaghi loosening earth pressure based on theory of main stress axes rotation, *Rock Soil Mech.*, **31** (2010), 1402–1406.



AIMS Press

©2019 the Author(s), licensee AIMS Press. This is an open access article distributed under the terms of the Creative Commons Attribution License (<http://creativecommons.org/licenses/by/4.0>)