

---

*Research article*

## Energy saving potential diagnosis for Moroccan university campuses

**Badr Ouhammou<sup>1,\*</sup>, Fatima Zohra Gargab<sup>2</sup>, Samir El idrissi kaitouni<sup>3</sup>, Slimane Smouh<sup>4</sup>, Rachid El mrabet<sup>5</sup>, Mohammed Aggour<sup>1</sup>, Abdelmajid Jamil<sup>2</sup> and Tarik Kousksou<sup>6</sup>**

<sup>1</sup> Faculty of Science of Kenitra, Ibn Tofail University, Morocco

<sup>2</sup> Higher School of Technology of Fez, Sidi Mohamed Ben Abdellah University, Morocco

<sup>3</sup> Green Energy Park, Benguerir, Morocco

<sup>4</sup> High School of Technology, Faculty of Sciences, Moulay Ismail University of Meknes, Km 5, Agouray Street P1, Meknes 50040, Morocco

<sup>5</sup> Marafik Berkane company, Berkane city, Morocco

<sup>6</sup> Laboratory of Engineering Sciences Applied to Mechanics and Electrical Engineering (SIAME), University of Pau and Pays de l'Adour/E2S UPPA, EA4581, 64000, Pau, France

\* **Correspondence:** Email: [badr.ouhammou@uit.ac.ma](mailto:badr.ouhammou@uit.ac.ma); Tel: +212608559613.

**Abstract:** Public buildings are energy-intensive users, especially when energy management is lacking. More than ever, the use of energy efficiency strategies and renewable energy sources (RES) in buildings are a national priority for Morocco in order to improve energy self-sufficiency, replace fossil fuel use and lower energy bills and greenhouse gas emissions. Relating to the exemplarity of the Moroccan government in terms of energy efficiency and sustainable development, the study support that aim and presents results of a deep energy performance analysis of more than 20 university campuses across Morocco, which has concluded that around 80% of the energy consumed in the university campuses is designated for lightning and hot water for sanitary use. Later, this study examined the potential for energy saving and the environmental benefits of implementing actions to reduce energy demand from the grid, considering the use of on-site solar energy. Thereafter, the study aimed to analyze the impact of RES integration in public university campuses, namely the photovoltaic (ESM1) for electricity output and solar thermal system for hot water use (ESM2), to assess the techno-economic-environmental performance on building energy consumption reduction. Hence, the paper reported a detailed energetic-economic and environmental (3E) analysis simulation for campuses by integration of the two Energy Saving Measurements (ESM). The results showed that the integration of ESM1 system can reduce the annual energy demand by 22% and the energy bill by 34%, whereas the integration of

ESM2 achieved 67% in energy saving. According to the analysis of the results, the integration of ESM1 is expected to save 6044 MWh of electrical energy annually on the 30222 MWh for all campuses and 2559 MWh for ESM2 which is equivalent to 284 m<sup>3</sup>/yr of diesel. With the reduced energy consumption, it is possible to cut down fossil fuels for electricity production and offset greenhouse gas emissions by 672 tons of carbon dioxide annually. Besides, the evaluation of results showed that the energy performance indicator was reduced from 530 kWh/bed /yr to 248 kWh/bed/yr, which represents 56% of energy saving.

**Keywords:** buildings low consumption; energy efficiency; PV simulation; solar thermal; carbon footprint

---

**Abbreviations:** CO: coal; DHW: Domestic hot water; DNE: discount net externality; 3E: energetic-economic and environmental; ESM: energy saving measurement; EP: Energy Provided; ES: Energy Saved during the System Life Cycle; ECD: The carbon dioxide emitted by specific resources; FPC: Flat plate collector; FF: fossil fuels; LED: light-emitting diodes; HPS: high-pressure sodium; NES: National Energy Strategy; NG: natural gas; OI: oil; PEM: The percentage in the energy mix of these specific resources; PV: photovoltaic; PD: The payback duration; PEF: primary energy conversion factor; RES: renewable energy sources; RECD: reducing carbon dioxide emission; SC: scenario

## 1. Introduction

The rapid population growth and urban expansion have resulted in an increase in worldwide energy demand. Because of the ever-increasing exploitation of energy resources, development should occur in tandem with energy production and consumption [1]. Thus far, the construction & buildings sector accounts for 32% of total global energy use. Furthermore, this sector accounts for roughly 20% of global greenhouse gas emissions [2]. Rising energy demand in developing nations has prompted increased attempts by numerous organizations to strike a balance between energy generation and energy consumption. Many studies that analyze the energy flow in buildings have been conducted in order to define the best course of action for energy efficiency and energy conservation activities. Energy efficiency is critical for rationalizing energy input, lowering energy costs and carbon footprint, and maintaining a comfortable environment in buildings [3]. While there are many ways to achieve energy efficiency for the building and construction sector, energy audits are considered the most efficient tool largely used to reach higher efficiency levels.

### 1.1. Background literature review

To address this issue, governments all over the world have rolled out programs and governmental policies to increase energy efficiency in the construction and buildings sector [4]. In this context, Morocco is engaged in significant economic and social reforms [1], including a shift to green development [5]. Morocco approved a National Energy Strategy (NES) in 2009, with the goal of improving energy supply security and availability, as well as increasing broad access to energy at competitive costs [6]. To attain these goals, a range of energy policies have been supported, with the major emphases on energy source diversity, growth of the national potential in energy resources (particularly renewables), promotion of energy efficiency, and greatly advanced integration in the regional energy system. In addition to this energy plan, the Moroccan government

has advocated an energy efficiency policy aimed at defining the roles of administrations and operators. The goals of this energy efficiency strategy are to establish an institutionalized public management system for energy efficiency concerns, as well as a proper legislative and regulatory framework, and to promote norms and standards. In this manner, Morocco's government also adopted Law 47-09 on energy efficiency [7]. According to Article 3 of the act, compliance with the standards related to urban planning, the "general building norms," which specify the rules for building energy performance, are required. These rules focus on ensuring an appropriate building energy balance for each climatic zone, taking into account the lighting, orientation, insulation, and thermal fluxes of the building, as well as any renewable energy contribution in line with the building performance level improvement. Such new standards apply to both new construction and restorations. In 2014, Decree n.2-13-874 [8] was issued, developing the set of thermal construction regulations (RTCM) in Morocco and establishing them as mandatory in November 2015. This decree defined a set of minimum thermal technical building envelope criteria, such as external walls, roofs, and windows. Furthermore, based on climatic zoning, yearly maximum thermal needs for both cooling and heating energy consumption are established [9,10]. Morocco's 2015 energy strategy established a goal of 20% energy savings by 2030 [11]. In terms of energy labeling for electrical items and home appliances, current Moroccan rules make photovoltaic products and solar thermal systems mandatory [12].

In a very specific context, educational buildings consume a significant portion of the energy utilized in the tertiary building sector, and their energy budget spending represents a significant financial burden for the country [13] and energy audit can help it achieve efficiency and reduce energy costs. In this sense, many energy audits for university buildings or higher education institutes, including campuses, have been completed and which has demonstrated that implementing energy efficiency measures can result in significant savings. As such, Hussain [14] conducted an energy assessment for a graduate engineering institution. The results showed that the potential energy savings from the action plan presented in the article were about 36% of total energy usage. Semprini et al. [15] did an energy audit for a graduate school of engineers and architects in Bologna. The results reveal estimated energy savings of 32% simply by improving heating energy efficiency. Singh et al. [16] conducted an energy audit for a Malaysian institution. The authors solely address electrical energy end-use and tackle the corresponding lighting and air conditioning action plan. It was discovered that the electrical energy-saving potential of the studied loads amounts to 10%. At the National Autonomous University of Mexico, Azucena Escobedo et al. [17] estimate energy consumption and associated greenhouse gas emissions for the buildings and infrastructures on the main campus (UNAM). The authors estimated the energy consumption in detail for each energetic element based on energy auditing levels I and II. The findings suggested that energy consumption could be 7.5% lower than in 2011 and CO<sub>2</sub> emissions could be 11.3% lower than in 2011 if energy efficiency technologies are applied for retrofitting and taken into consideration for new buildings in lighting, refrigeration, and air conditioning; and a hybrid system (solar-electric-LPG) is used for water heating.

Thewes et al. [18] provided the findings of an energy consumption study as well as prospective energy reductions for 68 school buildings. The study discovered that modest fixes such as insulation and air tightness may significantly cut energy demand. The authors calculated potential savings in the tertiary sector of 1% of the national annual fuel oil and gas consumption. Alajmi [19] conducted an energy audit to investigate energy conservation potential for an educational facility in a hot

climate (state of Kuwait). The author discovered that the building's electrical and mechanical systems were not adequately operated or maintained. Saving up to 49.3% of the building's yearly energy consumption was attainable by making some adjustments, with a payback time of less than six months. In 2008, the city of Paris (France) initiated an energy-saving initiative in schools with the goal of reducing usage by 30% [20]. More than 600 school buildings were involved in the initiative. The insulation and fenestration, as well as the heating systems, have been refurbished. By evaluating 100 schools, it was discovered that a saving of a total of 10 700 MWh of final energy end use, a reduction of 2300 t of carbon dioxide, and an annual savings of 85000 € may be realized. Butala [21] did research on 24 ancient schools in Slovenia to increase their energy efficiency. The analysis revealed considerable energy losses (about 89% than standards). According to the report, the proposed action plan can decrease losses and allow structures to adhere to the specified values. Dimoudi and Kosterala [22] also explored the possible energy savings in Greek educational facilities. They found, using modeling studies, that boosting insulation levels can lower heating usage by 29%.

On the other hand, Hamdaoui et al. [23] examined the energy consumption and environmental impacts of several construction scenarios for a Moroccan office building. The gathered data show that the best building option significantly reduces annual energy loads when compared to the baseline scenario. Estimates show that the annual drop in Agadir was around 20%, Tangier was about 48%, Fez was about 53%, Ifrane was about 56%, Marrakech was about 31%, and Errachidia was about 41%. According to Guechhati et al. [24], adding a 6 cm layer of extruded polystyrene insulation to the exterior of external walls can reduce the amount of heating and cooling that is required annually by 8.38 percent and 70.54 percent, respectively. Lafqir et al. [25] showed that combining wall insulation, roof insulation, and window type selection permits a thermal load reduction of more than 70% in all temperature zones of Morocco, with the exception of the cold one (Ifrane). The integration of renewable energy systems (RES) to achieve a net zero energy balance has been evaluated by several countries and areas. As a consequence, Good et al. [26] conducted a comparative analysis of the utilization of several solar energy solutions (solar thermal, photovoltaic PV), and photovoltaic-thermal (PV/T)) in order to attain a net zero energy balance for residential construction. The researchers found that a PV/T system could generate more energy than solar thermal collectors, and that a building composed solely of high-efficiency PV modules was the one that was most closely associated with a net-zero energy balance. Research on the impact of a building's passive characteristics on the structure's energy independence as a result of the addition of RES was done in Morocco by Chegari et al. [27]. The results showed that, especially in Ifrane city (cold zone of Morocco), thermal insulation had a significant impact on a building's capacity to produce its own energy in all the climates investigated. Given that this environment has a degree of energy independence that is 41.28 percent higher than the previous one. DHW production from solar thermal collectors, electricity generation from photovoltaic and small wind power systems, solar cooling (via absorption devices), and cooking using solar ovens are among the most often used techniques. However, in order to satisfy certain objectives (such as ones for the environment or the economy for a given climate), the NZEB, a building with the highest energy efficiency, requires examining a wide variety of feasible design possibilities [28]. Additionally, according to the Energy Efficiency Index (EEI) in kWh/m<sup>2</sup>/year, Adi Ainurzaman Jamaludin et al. [29] investigated the effectiveness of energy consumption at residential college buildings on the University of Malaya campus. As a consequence, the typical annual power consumption ranged from 24 to 120 kWh/m<sup>2</sup>.

Minimal research has been done on energy diagnostics in educational institutions, according to the reviewed literature. The integration of RES, HVAC systems, and lighting systems are the efficiency improvements that are most frequently addressed while looking through the suggested action plans.

### *1.2. Aims and objective*

The energy efficiency policy in Morocco grows up in the last decade by announcing a lot of policies for energy efficiency (EE). Indeed, Morocco's energy strategy has been developed in response to climate change specifically and because the country is an energy importer. It is centered on mobilizing Morocco's own natural resources, increasing the share of renewables in the energy mix, and making energy efficiency a national priority. In fact, the work focuses on the implementation of renewable energy resources (RERS) and energy efficiency (EE) as the major part of Morocco's energy strategy, as provided for in its National Plan for Renewable Energy and Energy Efficiency Plan. Morocco's energy strategy aims to save 20% in 2030 of total energy consumption [30,31]. Its adoption will allow for the creation of a diverse energy mix that will be optimized around certain technological choices that are both dependable and competitive.

This approach, which has the primary goals of assuring supply security and general energy price optimization; mobilization of domestic energy resources, including the enormous renewable energy. For instance, in the building sector:

- i) A national energy efficiency program in the construction sector.
- ii) Energy efficiency program for public buildings.
- iii) Appliance labeling for EE, under the Renewable Energy and Energy Efficiency Law 2009;
- iv) Low consumption light program in the public housing sector;
- v) Law 13.09 for integration of the PV system into the grid (interdiction for low voltage and without injection for medium voltage)

The current research reported the energy saving potential on the building sector of Morocco, especially in public buildings, which represent huge energy consumption and has a lack at the level of the energy law (13.09) that has been published in this sense. It only allows connection to the electrical network for the medium voltage network without energy injection. The law also prohibits the connection and injection of energy into the low voltage network. In this context, the current study aims to analyze the use of different forms of energy, i.e., electrical from the grid and thermal from combustible in a specific building which is the university campus. Results of detailed energy diagnostics have been reported for 21 campuses in different locations (zone climatic) of Morocco. The work is showing a deep analysis of profile energy consumption as a typical profile energy consumption and behavior for the public building. In another more profound way, the study carried out aims to prove the shortcomings of the exit law which concerns the integration of RES in the building sector, in particular for low voltage. The study focuses on the energy potential of the integration of two simple RES systems on the energy system (electrical and thermal) of public buildings. In fact, this study examines the potential for energy saving and the environmental effects of integrating actions to improve energy consumption, including solar energy. 80% of the energy consumed in the campuses is designated to lightning and hot water. In actuality, the study sought to examine the RERS integration in the university's public campuses, specifically the photovoltaic (ESM1) and solar heating system for producing hot water (ESM2), in order to evaluate the system's techno-

economic-environmental performance in terms of lowering building energy consumption, generating economic benefits, and lowering greenhouse gas emissions.

Although poor works of the energy potential analysis saving in a specific building energy system as presented previously, most of them have a major drawback. Indeed, the current research presents a real study of the actual appliance of the Moroccan energy policy which is not found in the literature. The main contributions of this work are summarized as follows:

- A level 1 and partial level 2 energy audits were carried out on 21 campuses in the different zone of Morocco by following the ISO 50002 method.
- The study proves that the energy potential saving in the public building has a huge effect in the profile energy consumption and show how much law 13.09 is poor for the integration of RES system in the low voltage network (domestic application).
- The paper thoroughly examined the integration and coupling of solar energy into a particular energy system building. It also studied the effect of the unsteady energy flow and low energy density make it difficult to collect, and convert, which is why the current paper has developed as a solution to maximize the mix of renewable source use and maximize its efficiency.
- The viability and dependability of a built solar system (electrical and thermal) were proved in actual physical conditions and in a dynamic environment, including altitude, longitude, the direction and position of the sun, tilt, humidity, and real solar fluctuation.
- Energy dashboard has been developed to monitor, manage and forecast the energy situation of each campus.

The work structured after the introduction (section 1) as follows: section 2 presents the methodology follows in this deep analysis and data collection, section 3 presents general energy diagnostic for all campuses by presenting the detailed results of energy auditing for different forms and uses of energy; section 4 focuses on a detailed energy analysis of one campus such as a case study in order to assess how the energy is managed in this type of tertiary buildings; section 5 contains the discussion and projection analysis saving energy on the whole 21 campuses by implementation of the two energy measurement savings (ESM); the paper ended by a conclusion (section 6).

## **2. Methodology and data collection**

One of the best ways to identify, evaluate, and enhance the energy performance of existing buildings is through an energy audit [32,33]. This multi-dimensional study's objectives are to identify strategies for enhancing energy efficiency and estimate the financial advantages. This research examines the majority of electricity-based consuming systems in the audited facility and is classified as a category II energy audit by ASHRAE (American Society of Heating, Refrigerating, and Air Conditioning Engineers) [34]. The approach used in this study includes a number of phases that are explained below and illustrated in the following Figure.

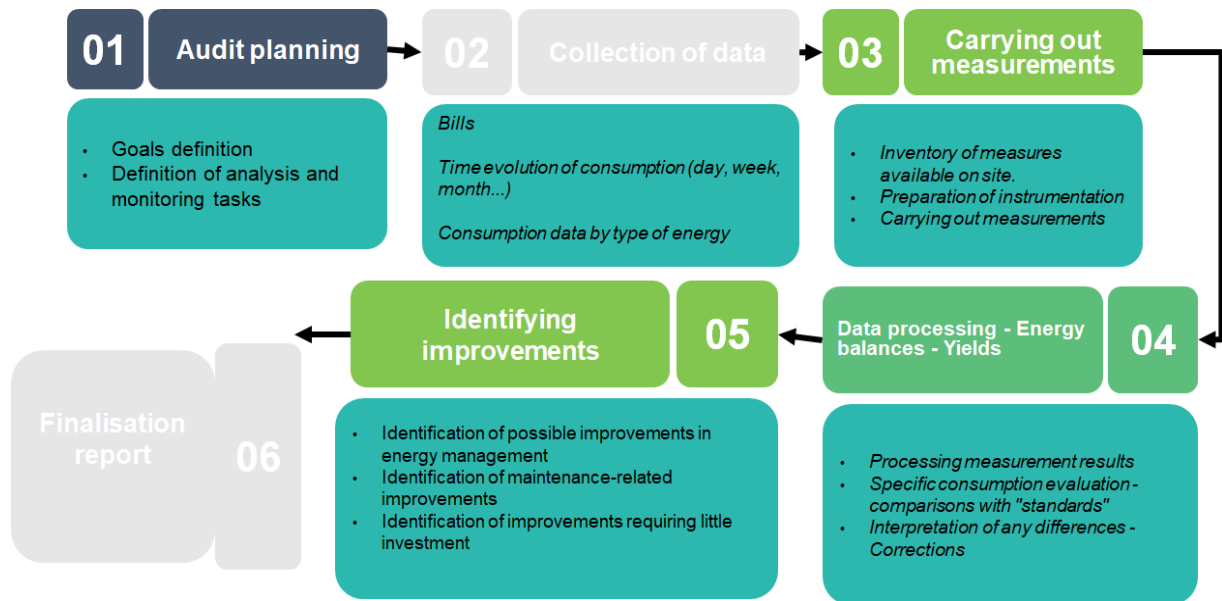

**Figure 1.** Methodology and step of the study research and data collection.

*a) Step 1: Preliminary visit*

Numerous visits were made after goal-setting and planning to gather the information needed to drive the energy audit operations. The information below was put back together:

- Campuses' architectural plans
- The last three years' worth of electricity bills to:
  - ✓ Study the variations in the monthly electricity consumption
  - ✓ Define the energy consumption during each time slot;
  - ✓ Verify the quality of the specified subscribed power;
  - ✓ Calculate the transformer's maximum load rates;
  - ✓ Assess the Displacement Power Factor (DPF) of the electricity system;
- Inventory of energetic system: external/internal lighting systems, boiler, pumps, air conditioner, lab tops, and etc.

*b) Step 2: Diagnosis and measurements*

In this stage, the electric installation on the campus will be examined for operational issues. It was feasible to identify the causes of energy losses and provide a suitable action plan using the measurement instruments. The following measurements were performed:

- The installation of an electrical network analyzer at the faculty's main circuit breaker. For 48 hours in a row, the analyzer continually recorded all of the electricity's characteristics. This measurement's objectives were to identify daily variations in power consumption and evaluate the quality of the electrical energy delivered;
- The operation of the capacitor banks placed in the transformer station was evaluated using the multi-meter clamp.

*c) Step 3: Data treatment and analysis*

After finishing step 2, we created an extensive energy audit report that included all the data gathered, all the investigations completed, all the suggestions, and all the planned actions. In this step

all results are generated on the basis of the data treatment and solution proposed in this research paper present.

*d) Step 4: Decision-making*

Finally, based on the available financial resources and other technical restrictions, the research team helps the decision-maker validate and implement the retained energy efficiency initiatives.

The data collected contains:

- Electrical bills of 21 campuses
- Combustible bills of 21 campuses
- Measurements electrical of transformer that feed each campus
- Data collected and treated from a questioning form developed which concerns the: scenario of use the equipment, inventory of the equipment and etc.

### **3. Results of general energy diagnostic**

This section presents a summary of energy audits for 21 university campuses. We undergo an energy diagnosis of different forms, in particular, the electricity consumption for different end uses (lighting, air conditioning and electric and electronic equipment like computers, Wifi modems for Internet, audio-visual and video conferencing technologies, and equipment for kitchen) and thermal energy for the production of hot water and heating.

#### *3.1. Energy consumption by shape*

Six types of energy are used in the university campuses occupied by scholars. These are electricity used mainly for lighting and electrical equipment, fuel diesel, anthracite, fuel oil No. 7, propane and butane are used for the production of hot water (HW) and for catering, seven campuses use propane and three others use butane. Diesel fuel is also used for the car fleet in use. Only a few university campuses (five) are equipped with solar thermal collectors for the production of hot water.

##### **3.1.1. Electrical consumption**

The electrical energy consumption of the 21 university campuses is illustrated in Figure 2a below represented more than 164767 MWh/yr in 2017 and 17331 and 17555,3 MWh/yr for 2018 and 2019 respectively, with an increase of 1.3% between 2018 and 2019. The cost of this energy consumption changed from 1935056 \$/year (2017) to 2406425 \$/year (2019). In addition, the cost per kilowatt-hour varied from 0.104 \$/kWh in campus 12 up to 0.3 \$/kWh in campus 17. The national average was 0.136 \$/kWh, against 0.131 \$/kWh in 2019, an increase of 3.9%. The reason for which the cost of kWh in Campus 17 is higher in comparison with other campuses is because the former has a low-voltage electricity subscription for the power supply of the entire campus and electricity consumption exceeds the third portion with regard to a reference set by local distributor.



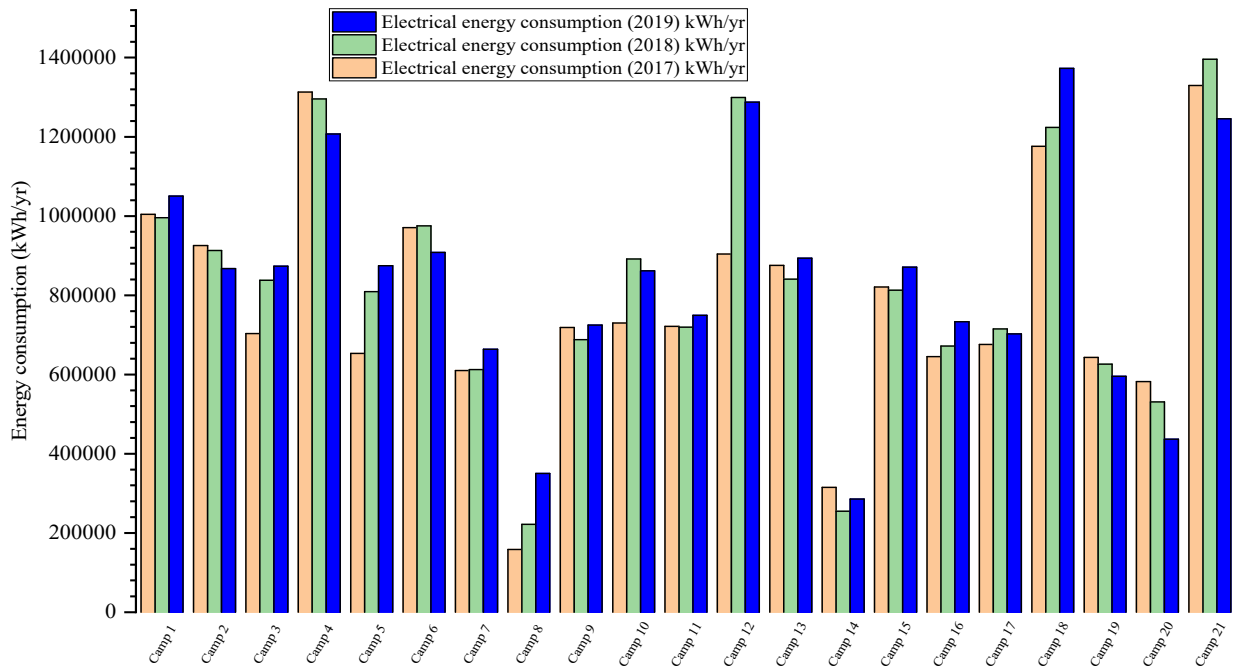

a)

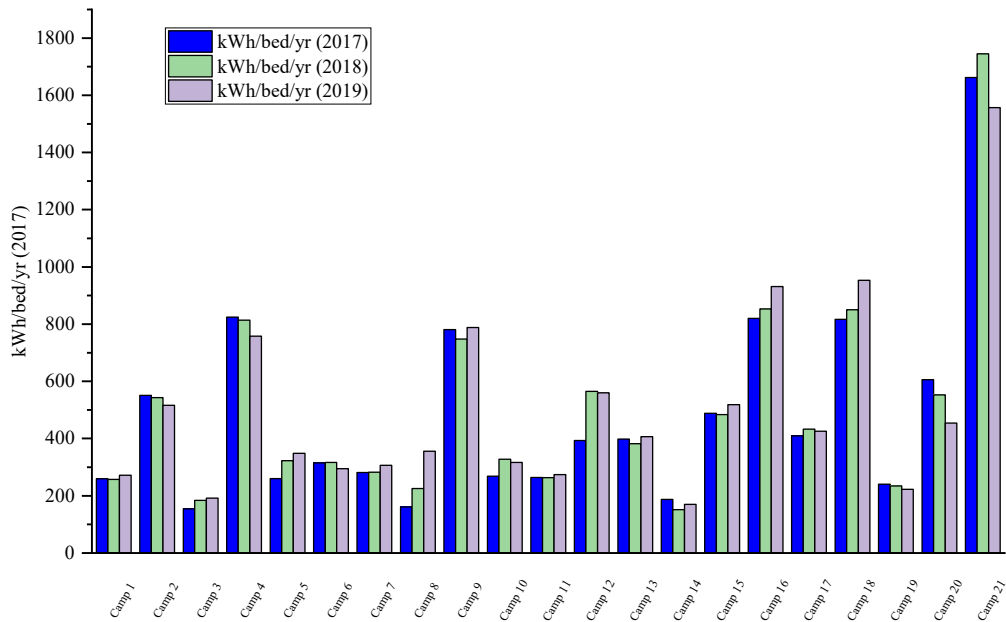

b)

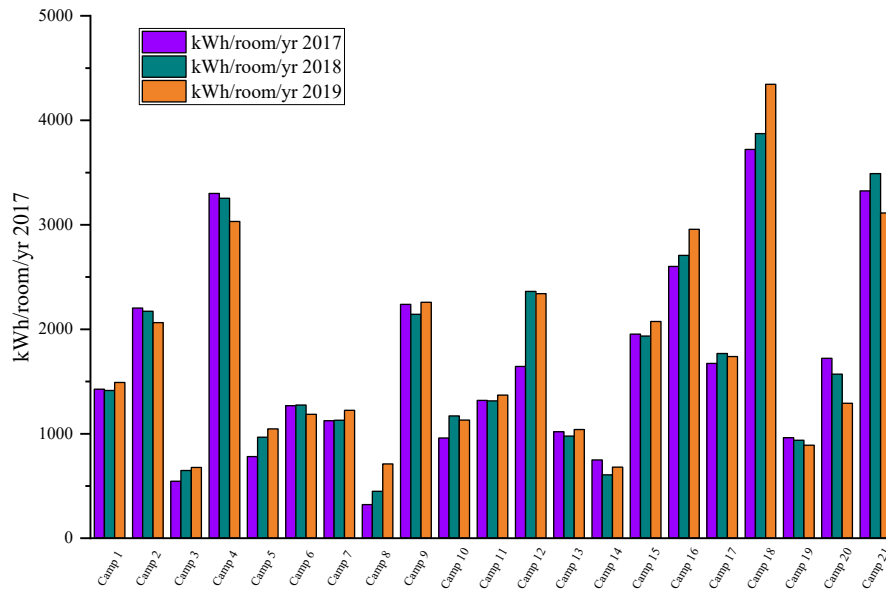

c)

**Figure 2.** a) Yearly electrical energy consumption in kWh; b) first Energy Index Consumption on kWh/bed/yr; c) second energy index consumption on kWh/room/yr.

Further, the first index energy consumption on kWh/bed/yr indicates that the energy consumption ranged from 483,501 and 506 kWh/bed/yr for 2017, 2018 and 2019 respectively as illustrates in the Figure 2b. Knowing that the total number of beds is equal to 42987 beds in the whole campuses and is not changed during the period study. The high value of the current energy index is recorded for campus 21 around 1633 kWh/bed/yr, because it contains a lot of electrical equipment and also this campus is equipped with a small kitchen for 4 rooms. Besides, the second energy index (kWh/room/yr) ranged from 1660 (kWh/room/yr) in 2017 to 1750 (kWh/room/yr) in 2019 as illustrated in the Figure 2c. It should note that the number of beds per room varies from 1 bed per room to 11 bed per room with an average of 3.7 bed per room.

### 3.1.2. Propane, fuel oil and diesel

Propane is used for catering in seven campuses such as campus 1, 11, 12, 13, 17, 19 and campus 21 as illustrated in Figure 3. The consumption for three Campuses (campus 12, 13 and 21) are at their own expenses, whereas for the remaining campuses, the propane is at the expense of private companies responsible for the catering service.

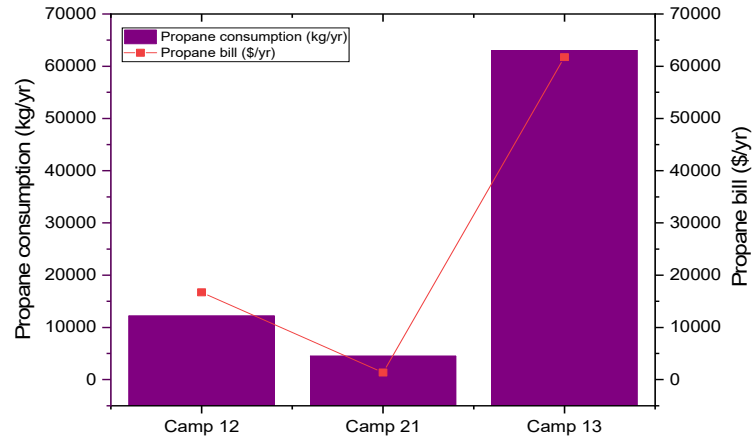

**Figure 3.** Propane consumption of the most consuming university campus.

For the fuel oil No. 7, it is used for the production of hot water by a single campus which is the campus 5. The consumption was around 100 tons per year with an amount of 69571 \$. Besides, the diesel is used exclusively for the production of hot water in eleven campuses as presented in the Figure 4, five campuses for car fleet in use and for both HW and car fleet in use in two campuses. Figure 4 below shows the diesel consumption by campus. Diesel consumption represents 631923 liters/yr, with a bill of 638148 \$.

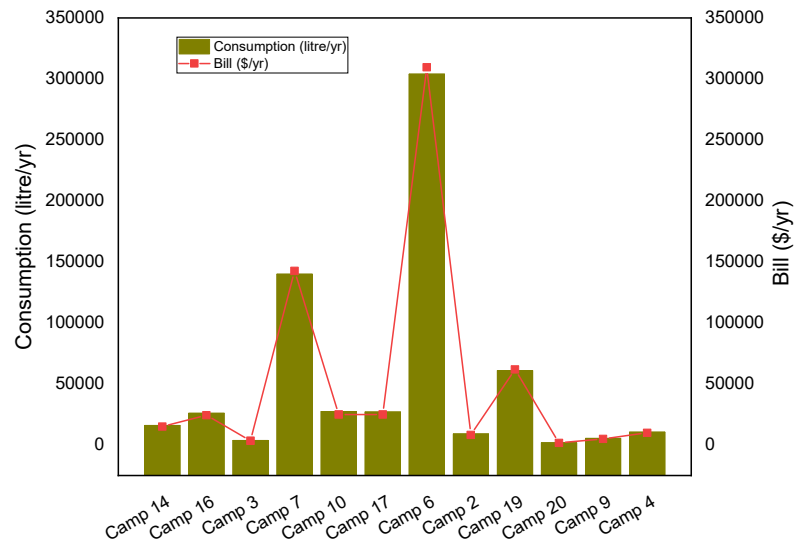

**Figure 4.** Yearly diesel bill and consumption.

The consumption of diesel fuel in campus 7 and campus 6 represents 71.5% of the total consumption of the 12-university campus. Figure 5 below shows that diesel is used mainly for HW, with 90% of the total consumption. The diesel consumption for car use is limited to 2% whereas 8% of the consumption is mixed between HW and car use since the data provided by the university campuses do not allow a distinction to be made between consumption for HW and for the car fleet.

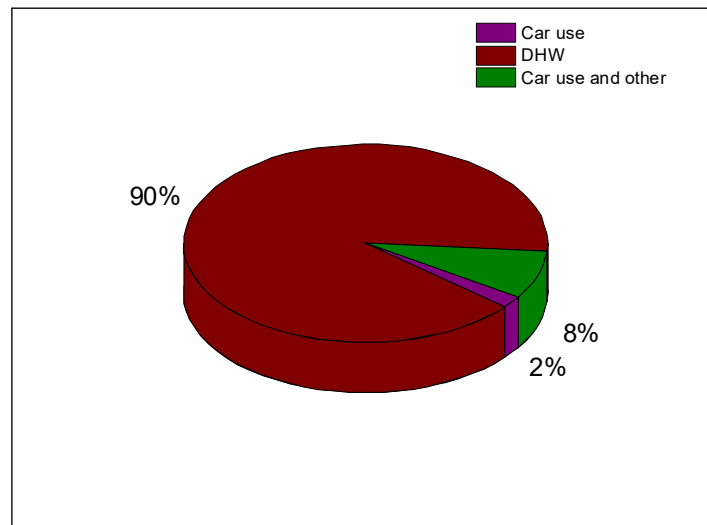

**Figure 5.** Distribution of the diesel consumption.

### 3.2. Energy consumption per use

#### 3.2.1. Lighting

For the lighting use, the study focuses on the outdoor lighting. Thus, the inspection of outdoor lighting consumption for 21 campuses represents 1211.2 MWh/yr which represents an average of 9% of the total electrical energy consumption.

The number of watts per luminous tip is between 20 W and 1000 W. Outdoor lighting consists of several technologies: light-emitting diodes (LEDs), high-pressure sodium (HPS) and compact fluorescent lamps. Figure 6 below shows that the campus 12 has the highest lamp power intensity, followed by the campus 19 and 8 respectively. It is possible to decrease significantly the consumption by switching over to the LED bulbs instead of compact fluorescent bulbs.

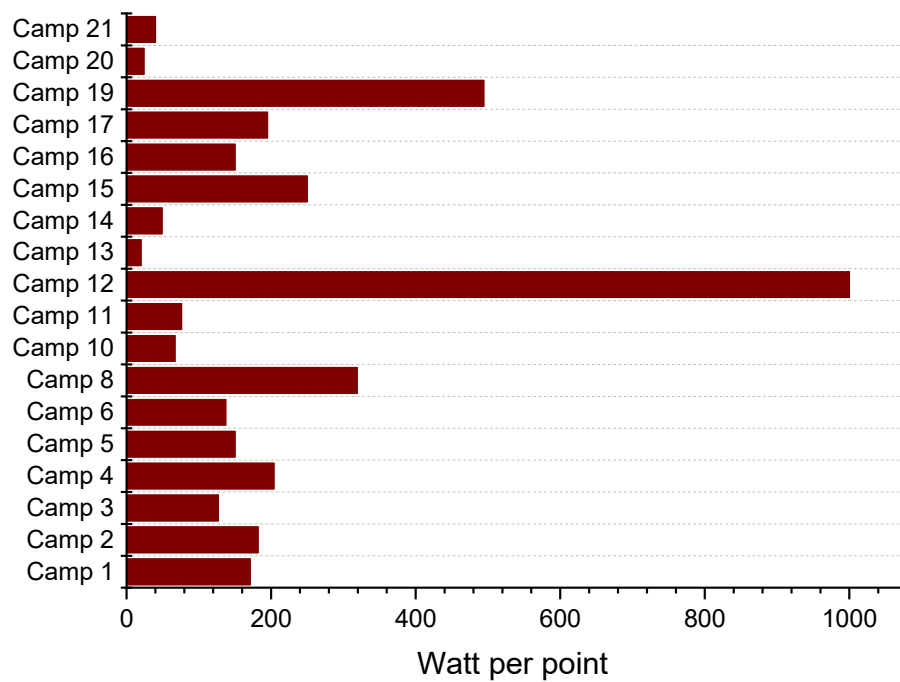

**Figure 6.** Average lamp power (outdoor lighting).

### 3.2.2. Hot water

However, the consumption of thermal energy for hot water varies from one campus to another. The lowest ratio was obtained in the campus 19 and campus 2, as they use solar heating in parallel. This ratio is 40 kWh/student/year for the campus 21 and 65 kWh/student/year in the campus 2. For the other campuses, the ratio varies from 65.95 kWh/student/year in campus 4 to 1402 kWh/student/year in campus 7 only for hot water.

**Table 1.** Distribution of DHW and electricity consumption.

Campus	Diesel (DHW) Litres/yr	Electricity kWh/yr	Total DHW + Electricity kWh/yr	DHW Percentage/Total %
Camp 14	18 560	285 666	471 266	39%
Camp 16	30 160	632 188	1 034 938	29%
Camp 6	162 400	782 792	2 532 039	64%
Camp 7	352 640	572 055	4 189 984	84%
Camp 2	10 440	747 598	971 614	11%
Camp 19	70 760	595 386	1 302 986	54%
Camp 4	12 180	1 206 880	1 145 414	9%

#### 4. Case study: campus 17

The pilot campus is a university campus with a capacity of 1100 people and 410 rooms. It is composed of Five pavilions (student accommodation); an Administration building; a Restaurant and refreshment cafeteria; Health center; Boiler room; Study rooms; Sports Hall; Multiservice room and staff accommodation.

##### 4.1. Electrical energy consumption

The campus has a low-voltage electricity subscription for the power supply of the entire campus. The price per kilowatt-hour is billed according to this bracket at 0.231 \$ including tax. The price at low voltage is higher than at medium voltage in Morocco. Indeed, the average price per kilowatt-hour at medium voltage is 0.12 \$/kWh including tax. The campus 17 electricity consumption in 2017 was 582631 kWh/yr, i.e., 130444 \$/yr as illustrated in Figure 7.

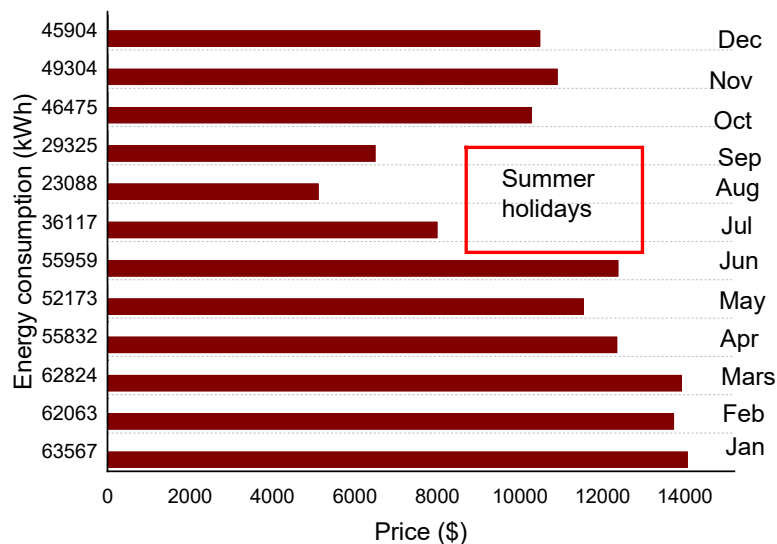
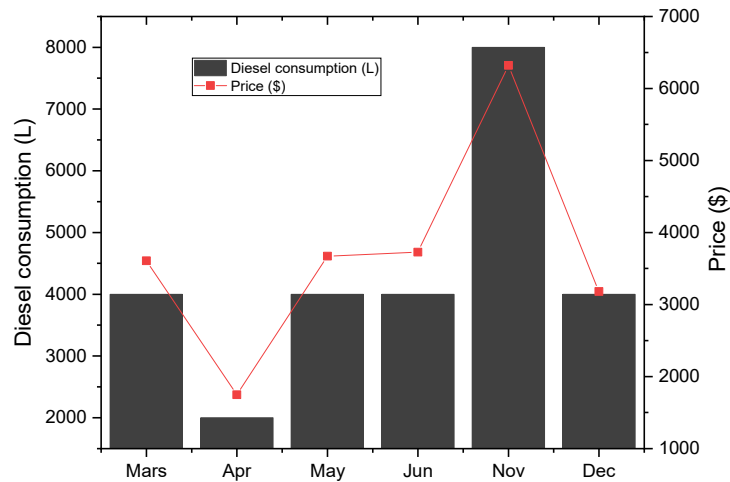

**Figure 7.** Evolution of electricity consumption.

Figure 7 shows the monthly consumption. It varies from 23,088 kWh in August to 63.567 kWh in January, with an average of 48.553 kWh. Summer consumption can be explained by the accommodation for 43 staff and the partial presence of administration staff.

##### 4.2. Hot water and air conditioner

The campus has two diesel condensing boilers (107 KW for each one) for its hot water production needs. The diesel consumption for one typical year is illustrated in Figure 8. Diesel fuel is used to produce hot water using boilers. The quantity of diesel delivered annually is 26010 liters, or 22466 \$/y.



**Figure 8.** Diesel fuel consumption.

The water leaves the boiler at a temperature of 100 °C (measurement), while the boiler plug displays a maximum temperature of 90 °C and passes through an exchanger emerged in a storage tank. The water is stored in a tank of about 1000 liters (the thermometer indicates 60 °C). The storage tank is fitted with an additional 9 kW electric heater. The boiler is supplied directly from the drinking water network. In fact, the showers only have a 1000-liter balloon which is used for shared showers for all the students on the campus.

On the other hand, air conditioning as illustrated in Figure 9, is used in the offices, in the multiservice room (the room is used approximately 100 h/yr) and in the study room for the comfort of the occupants. The site is equipped with 19 split-system air conditioners. Consumption is estimated at 9.43 kWh/year, i.e., 1.6% of the site's total consumption. It was found that the study room doors stayed open while the heating was on, which increased the energy consumption of the air conditioner.

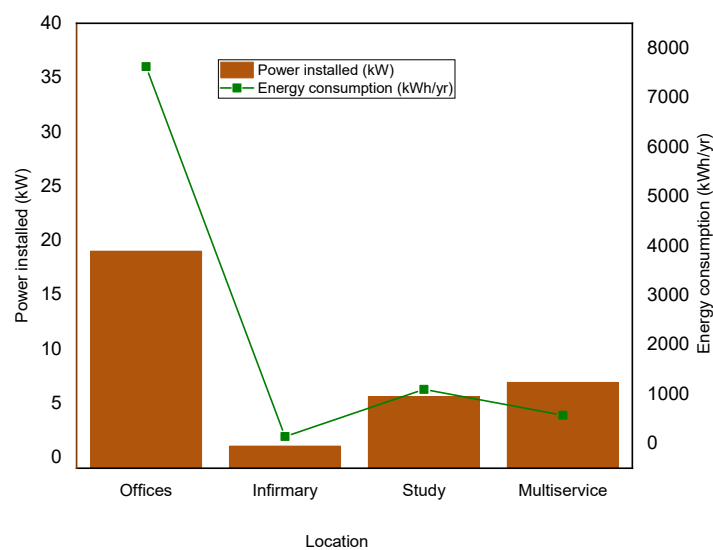

**Figure 9.** Inventory and energy consumption of air conditioning equipment.

### 4.3. Lighting

Taking into account the lighting time assumptions, power consumption for lighting represents approximately 283700 kWh per year, not counting conventional ballasts, or 49% of the campus total consumption. This consumption is distributed as follows:

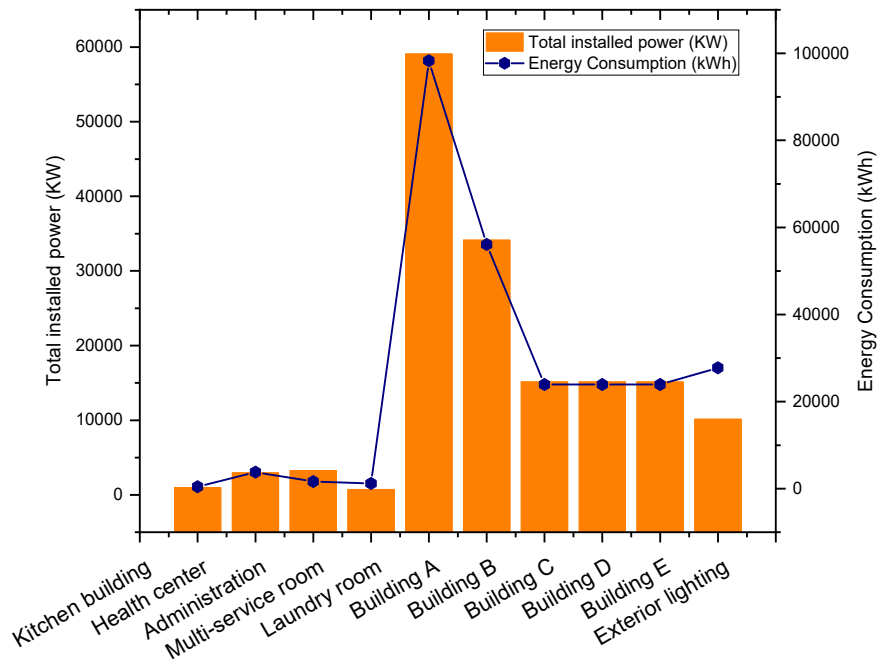

**Figure 10.** Lighting inventory for the campus concerned.

It should be noted that 56% of the lights installed are fluorescent and 35% are incandescent. These fixtures are energy consuming and should be replaced with LED fixtures as illustrated in the Figure 11 below.

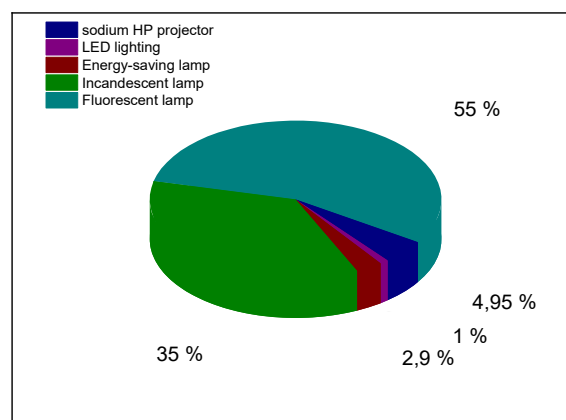

**Figure 11.** Repartition of installed power by type of lamp technology.



The table below summarizes the energy consumption of the pilot campus distributed from lighting (energy-intensive part) to office activities (minimum energy consumption), not to mention the production of hot water (thermal consumption).

Therefore, on the basis on this detailed energy consumption situation, two Energy Saving Measures (ESM) was treated and analyzed in the paper.

**Table 2.** Summary of the distribution of energy consumption by use.

Uses	Consumption MWh/yr
Lighting	283.7
Office and administration	5.8
Air conditioning/heating	9.4
Kitchen	67.1
Various: sport gym, health center, laundry	38.5
Dorms	158.2
Other: water pumping and garden work	20

#### 4.4. Energy saving measurement (ESM) analysis

The technical opportunities for reducing energy consumption and expenditure identified on the case study include several measures; the main ones are grid-connected PV system for electrical energy production and solar thermal collector for HW production, which are being the subject of the technical and economic simulation below.

##### Condition and data climatic

**Table 3.** Climatic data of studied campuses.

N° Campus	Average of solar radiation intensity (kWh/m <sup>2</sup> /day)	Average of ambient temperature (°C)	Average of humidity (%)	Average of wind speed (m/s)
Camp 1	5.44	20.3	51.7	2.49
Camp 2	5.85	20.6	40	2.59
Camp 3	5.19	19.2	59.2	1.79
Camp 4	5.29	19.2	67.5	3.15
Camp 5	4.83	18.3	81	2.18
Camp 6				
Camp 7				
Camp 8	4.98	17.52	60.5	3.36
Camp 20				
Camp 21				
Camp 9	5.01	17.51	81.3	2.99
Camp 10	5.07	17.66	64.1	3.02
Camp 11	4.83	18.31	81.1	2.18
Camp 12				
Camp 13	4.99	17.41	81.3	2.99
Camp 14	5.07	18.08	73.4	5
Camp 15	4.99	17.41	81.3	2.99
Camp 16	4.68	19.26	70.5	4.50
Camp 17	4.99	17.41	81.3	2.99
Camp 18	4.99	17.38	62.9	3.69
Camp 19	4.98	17.52	60.5	3.36

Morocco has a significant solar and wind energy potential, as well as a strategic geographical location. Two significant renewable energy efforts, the Moroccan wind and solar projects, have been initiated in order to meet the national aim of raising renewable energy sources' proportion of the energy mix to 42% by 2020 [11]. Morocco, with its enormous sun resources (a potential of 2600 kWh/m<sup>2</sup>/year), providing a diverse variety of investment prospects in the thermal and photovoltaic solar energy sectors. Indeed, Table 3 below illustrates the climatic data such as average irradiation, temperature ambient and wind speed for each campus studied in the current paper.

#### 4.4.1. ESM 1: Photovoltaic installation for the production of electricity for self-consumption

This part consists of setting up a photovoltaic installation connected to the local network to meet part of the electrical energy needs during the day.

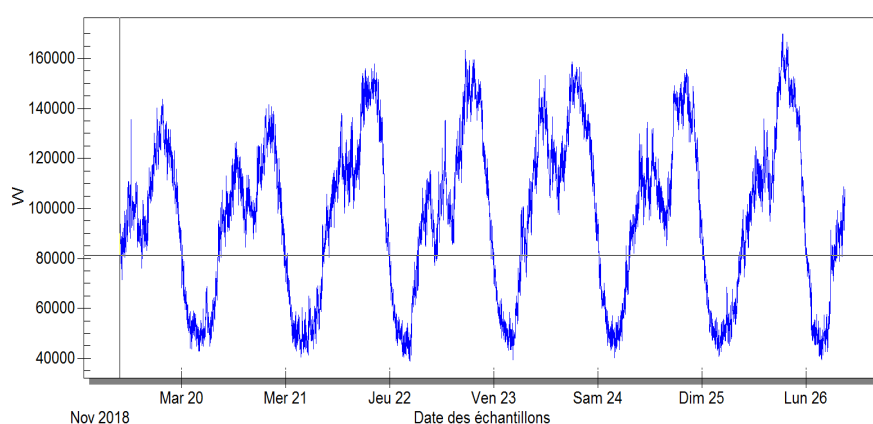

**Figure 12.** Network analyzer result for one week of campus operation.

The daily electrical power profile reached an average power of 80 kW as Figure 12 shows. The installation of the PV generator in the roof of the building or on the ground closest to the TGBT is possible knowing that the campus has an available area of land of 6000 m<sup>2</sup>. It should be noted that the law limits medium voltage injection in the event of a surplus in Morocco.

##### 4.4.1.1. Grid connected PV system description

The system proposed in this section is a hybrid system combining different sources, such as renewable energy systems and the national distribution network. These systems' main challenge is ensuring flexible energy management. The execution of the energy management plan must, in fact, balance supply and demand. These systems enable energy efficiency and lower power costs by ensuring both financial stability and environmental sustainability. As a result, restricting the regular usage of the national electrical grid, which often uses non-renewable sources, will assist the population's sustainable and social growth.

However, grid-connected systems are intended to provide clean electricity to the power grid as illustrated in Figure 13. Using PVsyst and TRNSys platform simulation, the applied loads were the annual consumption of campus 17 (case study) taking into account the consumption in peak hours, while the climatic data for the specific location are collected and implemented. The grid-connected

system turned out to be the most reliable option for the campus. The general configuration of the proposed system is described in Figure 12 for three scenarios (SC), i.e., the simulation for the ESM1 is conducted for 30 kW<sub>p</sub>, 60 kW<sub>p</sub> and 80 kW<sub>p</sub> respectively for SC1, SC2 and SC3.

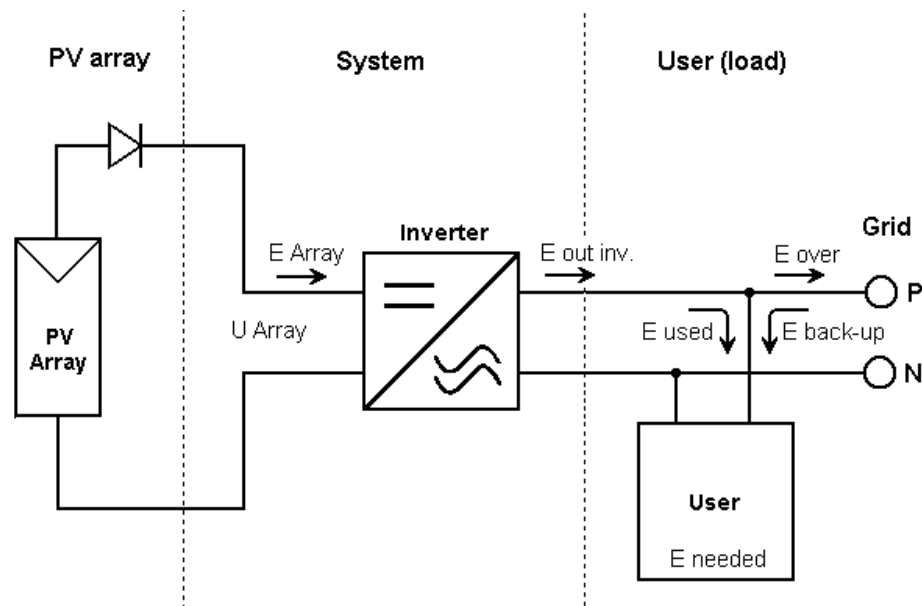

**Figure 13.** Simplified of PV generator system.

#### 4.4.1.2. Energy analysis

##### 4.4.1.2.1. Daily energy profile (winter season)

The simulated PV system for the campus (case study) does not have batteries, therefore the campus is connected to the grid (Figure 12), allowing it to work in diurnal intervals for self-consumption and reducing dependency on the utility grid.

Figure 14 shows the electrical energy (kWh) consumption from the grid during three months of the winter season. Besides, the Figure shows the daily production profile for typical days in December, January and February for each scenario.

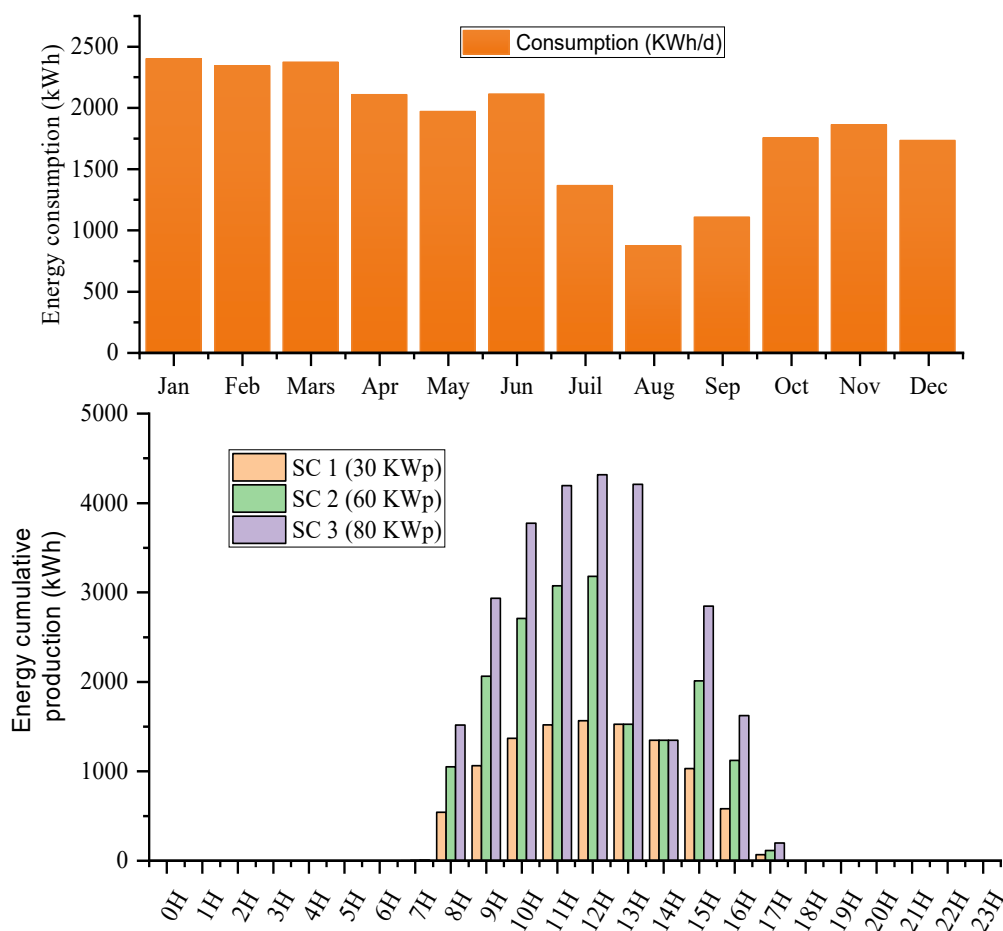

**Figure 14.** Monthly hourly sums of PV system production for the three scenarios for the winter season.

Indeed, Figure 14 shows the energy demand in campus, showing how the demand is higher in comparison to the energy supplied by PV systems in this period of the year (peak energy). The energy demand, by the campus, is over 74373 kWh/month. On the other hand, for the best month in term of energy production for this season, the monthly PV system production achieved only 5380, 10850, and 14970 kWh/month for the SC1, SC2 and SC3 respectively, while the energy supply is 2399 kWh per month. The results from the Figure indicated that the PV system reached a rate of the self-consumption for this season is around 62% for the SC3, 46% for SC2 and 22% for SC1.

#### 4.4.1.2.2. Monthly energy profile

The three scenarios (30, 60 and 80 kWp) have been developed and simulated to calculate the monthly and annual energy generation from the PV system. Overall efficiency is left to the default value of 85%. The results are summarized in Figure 15, where the monthly and yearly data are shown in Figures 14 and 15, respectively. The results show that scenario 3 exhibits the highest energy production while scenario 1 has the lowest energy generated. All proposed scenarios follow

the same generation trend over the year, where it can be noted that the maximum monthly generation is obtained in May and June.

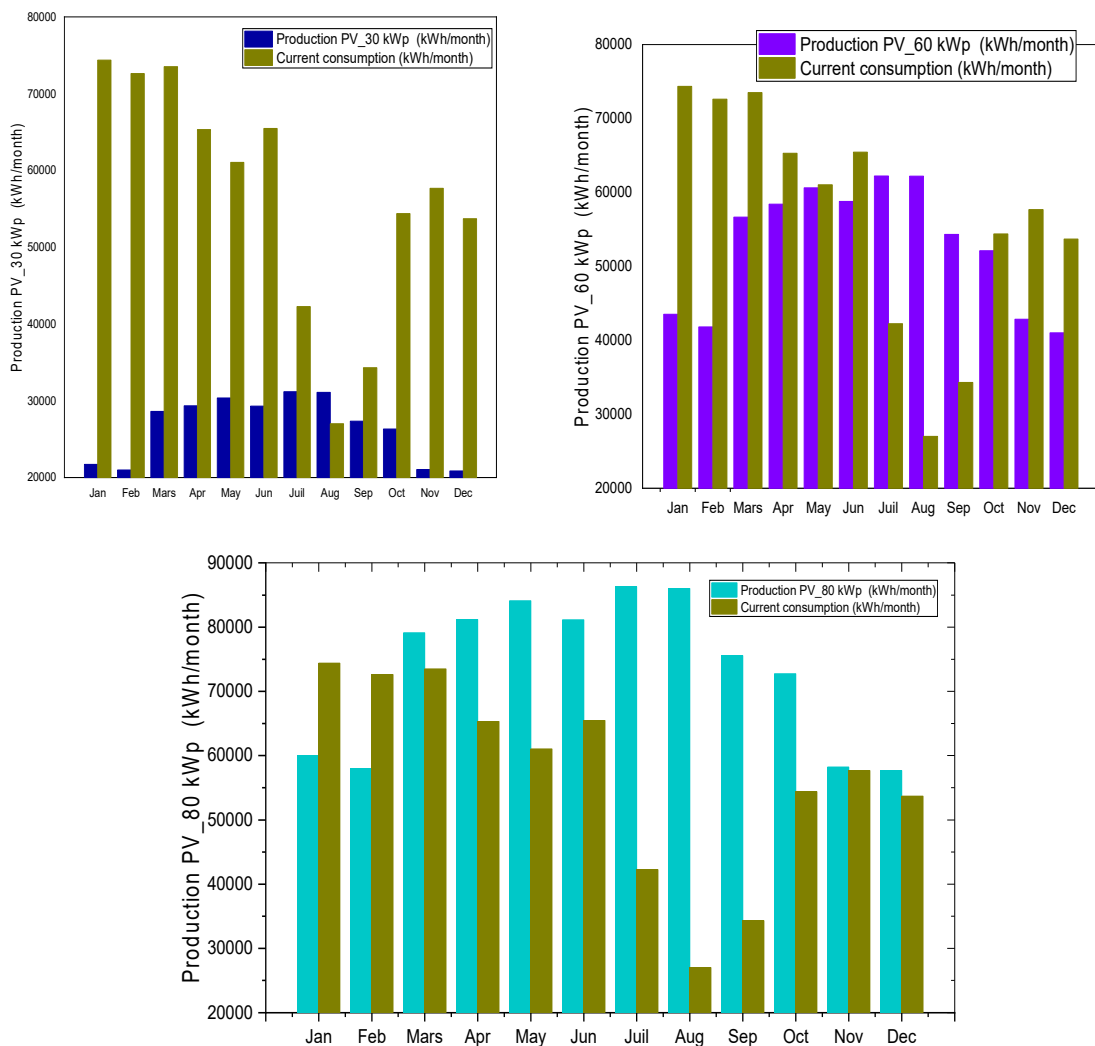

**Figure 15.** Monthly sum profile of PV system production for the three scenarios.

The simulation results of the grid-connected system in campus 17 indicated that the highest solar radiation occurred in the location site during July, with an average of  $1169 \text{ W/m}^2$ . During December, the lowest solar radiation intensity was at an average of  $416 \text{ W/m}^2$ . Figure 15 shows the average monthly produced energy from the three scenario of the PV system in the campus under study. The average monthly hourly sums of energy production were 600 kWh for scenario 1 occurred in December while the highest 1000 kWh in July. The lowest energy production of the PV plant for scenario 2 is 1737 kWh was recorded in December and the highest 2000 kWh in May. For the third scenario, the minimum produced energy 1800 kWh was in January while the highest produced energy 2783 kWh in July. In fact, the energy saving by the implementation of the PV system production allows for saving about 51% for SC1, 84% for SC2 and 94% for SC3 on energy consumption as illustrated in Figure 16 bellow.

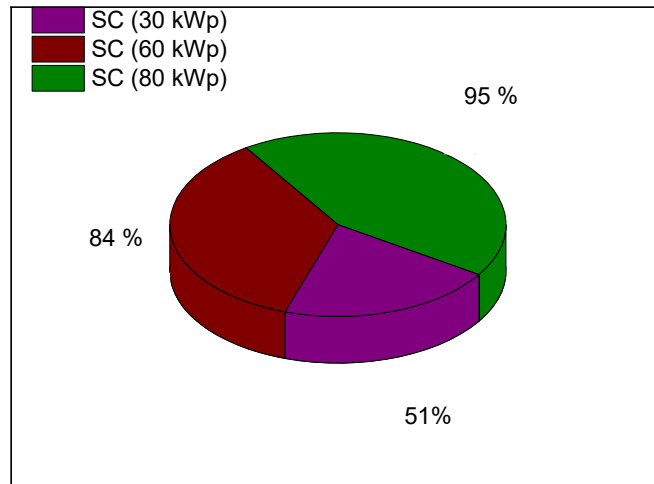

**Figure 16.** PV system solar fraction.

#### 4.4.1.3. Economic analysis

Figure 17 demonstrated the results of economic saving on the bill of each scenario of the implementation of the current ESM1 into the campus energy consumption. The cost of installing the PV system was 900 \$ per 1 KWp in Morocco including installation. Indeed, the cost of each scenario are 27000 \$, 54000 \$ and 72000 \$ respectively for SC1, SC2 and SC3.

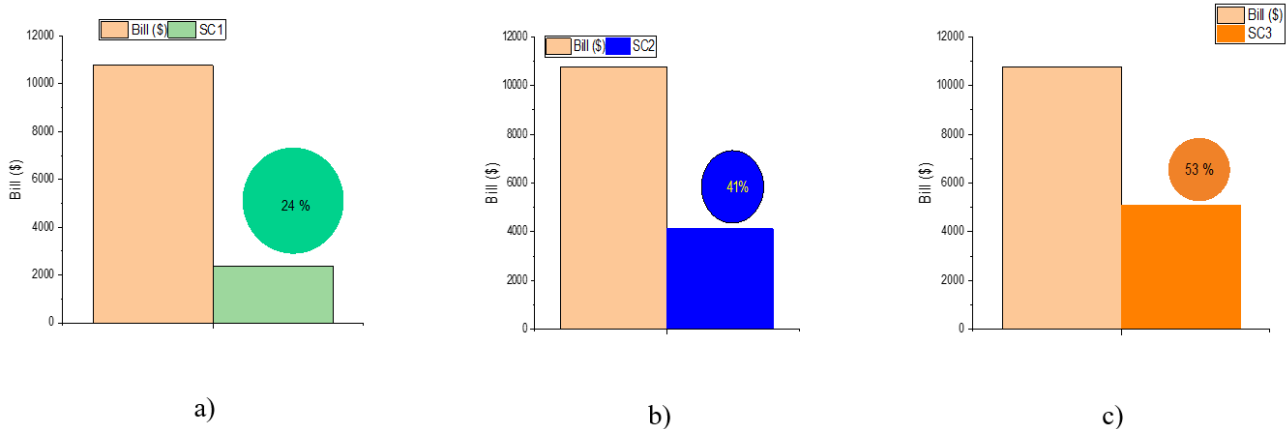

**Figure 17.** Earnings on Bill (\$) for each PV system scenario: a) scenario 30 kWp; b) scenario 60 kWp; c) scenario 80 kWp.

The bill analysis of the campus demonstrates an average of 10000 \$ per month with 56000 kWh/month. The average price of the kilowatt hour is 0.189 \$ per KWh. The Figure 17, presents the economic saving on bill associated with the realization of a PV plant on the campus. The results confirmed the profitability of a PV system at the campus case study, according to several indicators. NPV was positive and equal to 31013 \$, 53628 \$ and 64835 \$ for the 30 kW<sub>p</sub>, 60 kW<sub>p</sub> and 80 kW<sub>p</sub> PV system, respectively. This finding could also be expressed as 2386 \$, 4100 \$ and 5000 \$ profits on bill respectively for the SC1, SC2 and SC3. The values reported in this current analysis simulation

indicate that the scenarios proposed can cover a rate of 24%, 41% and 52% for SC1, SC2 and SC3 of the bill energy of the campus as illustrated in the Figure 17.

#### 4.4.1.4. Environmental analysis

Starting with a hypothetical energy mix composed of only fossil fuels, RECD (reducing carbon dioxide emission) value was calculated by using the following Equations:

$$RECD = ECD_{FF} - ECD_{PV} \quad (1)$$

$$ECD_{FF} = (ECD_{OI} \times PEM_{OI}) + (ECD_{CO} \times PEM_{CO}) + (ECD_{NG} \times PEM_{NG}) \quad (2)$$

The carbon dioxide emitted (ECD) by specific resources and PEM indicated the percentage in the energy mix of these specific resources.

The subscripts refer to the relevant resource: fossil fuels (FF), photovoltaic (PV), oil (OI), coal (CO), natural gas (NG), the unit of gCO<sub>2</sub> eq/kWh is mean that the equivalent quantities of CO<sub>2</sub> in one kWh.

According to the average values reported by [35], the following emissions data were proposed:

$$ECD_{PV} = 42 \text{ gCO}_2 \text{ eq/kWh,}$$

$$ECD_{OI} = 824 \text{ gCO}_2 \text{ eq/kWh,}$$

$$ECD_{CO} = 1149 \text{ gCO}_2 \text{ eq/kWh,}$$

$$ECD_{NG} = 568 \text{ gCO}_2 \text{ eq/kWh.}$$

According to GSE data [36], the following percentages were calculated as follows:

$$PEM_{OI} = 1\%,$$

$$PEM_{CO} = 21\%,$$

$$PEM_{NG} = 66\%.$$

In this way, the RECD value was calculated as 678 gCO<sub>2</sub> eq/kWh, obtained as the difference between 720 gCO<sub>2</sub> eq/kWh and 42 gCO<sub>2</sub> eq/kWh. With respect to each scenario of PV system, an overall reduction of 31,8 tCO<sub>2</sub> eq/yr, 57,12 tCO<sub>2</sub> eq/yr and 88,4 tCO<sub>2</sub> eq/yr was calculated during the first year of activity as illustrated in Figure 18 for each scenario (30 KW, 60 KW and 80 KW). Assuming an externality value of 26 \$/t CO<sub>2</sub> eq, The DNE (discount net externality) value for the first year of activity was calculated as 827 \$/year, 1486 \$/ year and 2300 \$/ year for the SC1, SC2 and SC3 respectively.

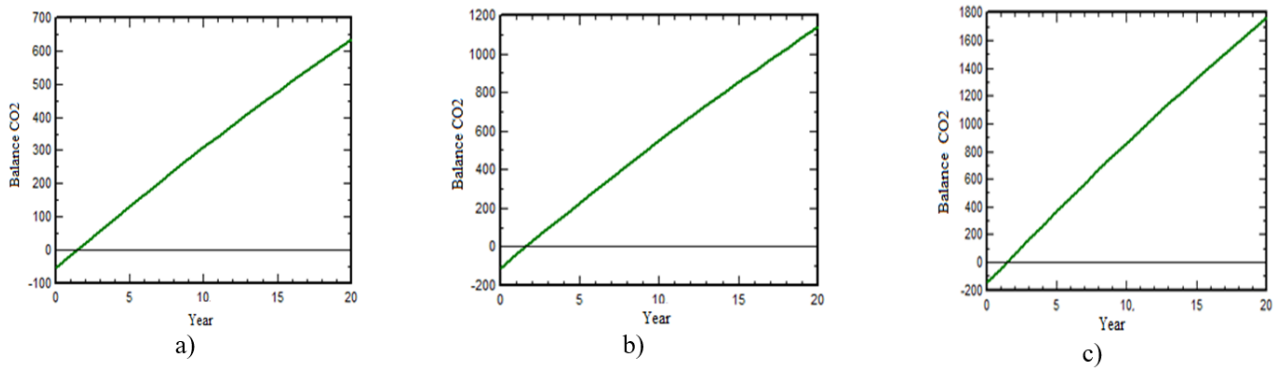

**Figure 18.** Carbon footprint of PV system, a) SC1; b) SC2 and c) SC3.

#### 4.4.2. ESM 2: Solar thermal for the production of domestic hot water

The current campus uses the fuel for the production of DHW through boilers. The energy consumption of the boiler has been estimated at an efficiency of 90% while the production of hot water is at 55 °C as illustrated in the following table.

**Table 4.** DHW production from the boiler system of the campus.

Diesel consumption (liter/yr)	DHW production (m <sup>3</sup> /yr)	Energy consumption (kWh/yr)
106000	2100	107000

##### 4.4.2.1. Description of system

Figure 19 shows the schematic diagram of Domestic hot solar water (DHSW). There are three major components in a DHSW: solar collectors, a hot storage tank and an auxiliary heater driven by electricity. When the outlet temperature of solar collectors ( $T_1$ ) is 10 °C higher than the water temperature in the hot storage tank ( $T_2$ ), the pump in the solar collection loop will be ON; and when the temperature difference between ( $T_1$ ) and ( $T_2$ ) is less than 3 °C, the pump will be OFF. The three-way automatic valve is modulated to maintain the outlet temperature ( $T_4$ ) at 60 °C (temperature desired to use). If ( $T_4$ ) is less than 50 °C, the auxiliary heater will start to provide 60 °C hot water to the demand use, and the auxiliary heater will be OFF when the output temperature ( $T_4$ ) is higher or equal to 60 °C.

To date, the most commonly used solar collectors in DHSW is Flat plate collectors (FPC) which use water as the energy carrier. The maximum efficiency of a well-designed FPC ranges from 40% to 60% with heat normally delivered between 50 and 75 °C. In this study, a typical FPC with market average performance is selected. Table 5 below shows the characteristics of the solar collectors.



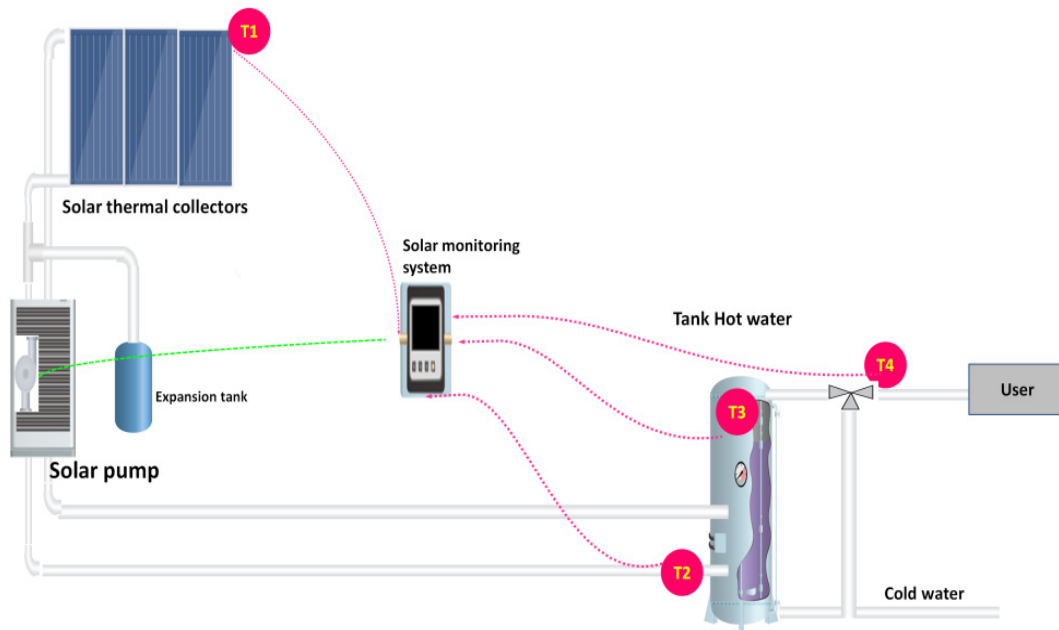

**Figure 19.** schematic diagram of a SHW system.

**Table 5.** Characteristics of solar collectors.

	Unit	Value
Optical efficiency		0,8
Loss coefficient first order	(W/m <sup>2</sup> . K)	5
Loss coefficient second order	(W/m <sup>2</sup> . K)	0,05

#### 4.4.2.2. Energy analysis

Figure 20 shows the profiles of solar irradiation during a two-day time period in December and May for the FPC in the chosen site. One is a partially cloudy day (winter season), and the other is a sunny day (spring season). The outlet temperature of the solar collection loop follows the trend of solar radiation. During the first day (Figure 19a), when the cloud covers the sun, the solar side cannot provide 60 °C hot water; hence the auxiliary heater is on. And the auxiliary heater is also triggered when there is no solar energy available. During the second day (Figure 19b), due to the rich sunshine, the solar system can provide the hot water demand for a long period, and even store the extra energy in the storage tank for night use. This detailed energy profile makes it possible to consider control sequences close to reality and calculate the annual performance of the DHSW with improved accuracy.

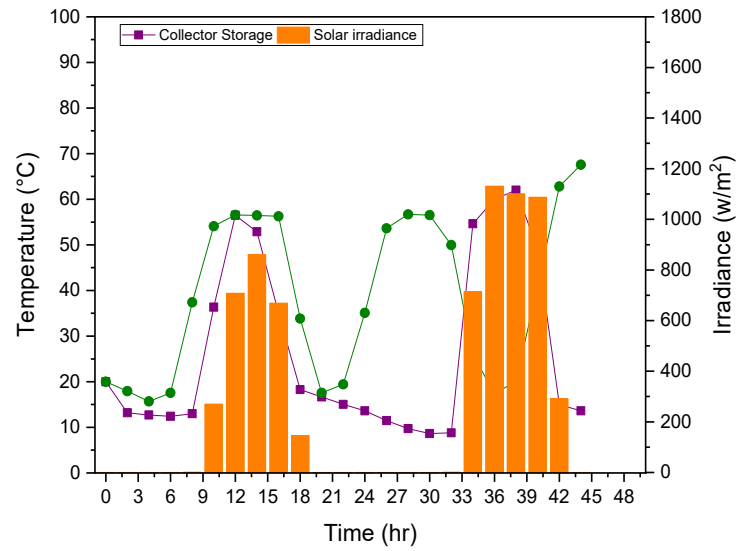

a)

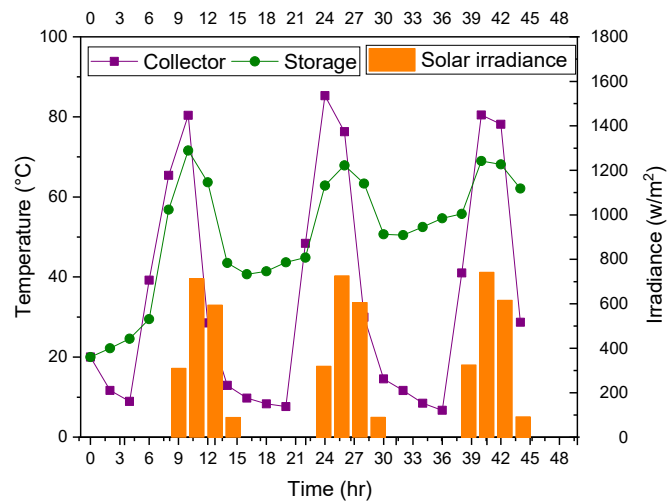

b)

**Figure 20.** Solar thermal system performance during two days of a): winter season (December); b) and spring season (May).

The annual solar fraction and collector efficiency for the installation in the chosen campus as shown in Figures 21 and 22 are calculated based on simulation over a one-year period.

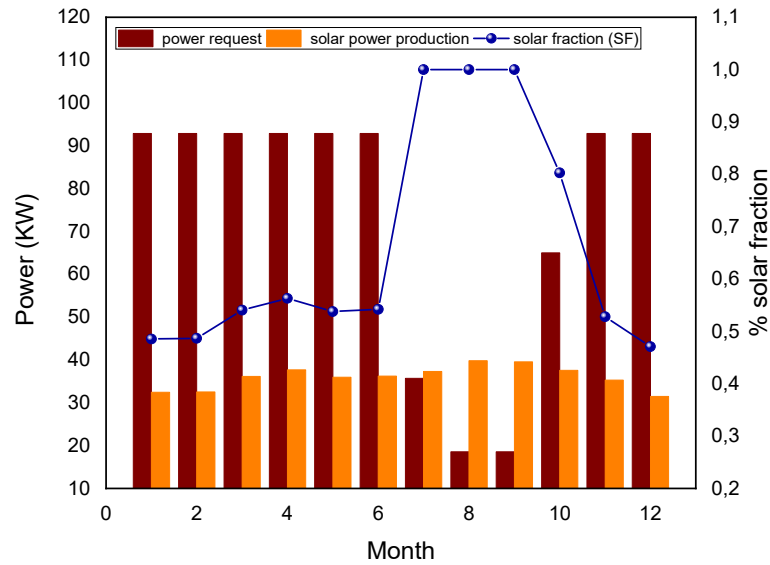

**Figure 21.** Monthly solar fraction and energy production of the SHW system.

In fact, Figure 21 presents the average daily energy power request from the hot water use, the solar energy production from the DHSW system. Indeed, the DHSW system achieved an average solar fraction of 55% during the worst climatic condition. Besides, the DHSW system has reached a maximum of 60% when the campus works on full time and at full capacity. In the contrary, the system achieved 100% in the summer season due to the high solar irradiance and a long day period. The overall trend of the monthly solar fraction is higher in the summer and lower in the winter where the largest difference was seen for campus (case study).

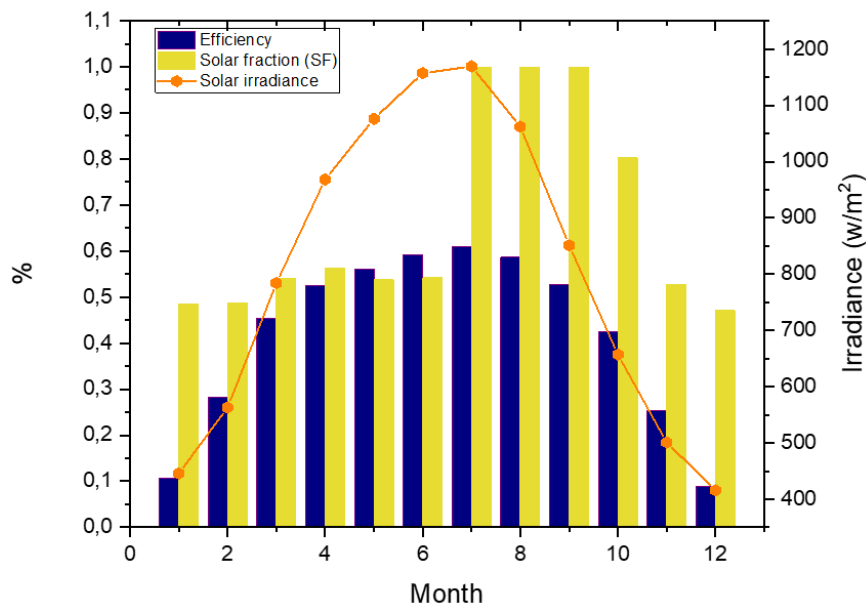

**Figure 22.** Monthly thermal efficiency and solar fraction.

From Figure 22, the results indicate that the thermal efficiency of the DHSW system ranged between 15% to 68% during the year which is very compatible with the bibliography work [37,38]. Indeed, the DHSW reached an average efficiency equal to 50% with a solar fraction of 55% which indicated that the system is very adequate to the campus for hot water production during its full capacity work.

#### 4.4.2.3. Economic analysis

The study's second main focus is the economic analysis. In this study's economics, the entire cost of the solar system is covered upfront (i.e., no credit payments are assumed). The system's thermal performance degradation is expected to occur at a rate of 2% annually, the economic analysis's time horizon is 20 years, and all other percentage variables (inflation rates and market discount rates) are averages from the last decade. According to the bill that was paid, electricity costs \$0.09 per kWh, and it is anticipated that supplemental diesel costs about \$1,1 per liter. A rate of energy was given throughout the life cycle of the solar thermal system (EP). This energy is primarily comprised of the energy needed for the building of the solar system, particularly the electric energy, which is calculated using a primary energy conversion factor (PEF). The mean PEF is assumed to be 2.7 for electric domestic use [39]. The EP during transportation and maintenance [38].

The approach developed in this work gives a general estimation of the EP based on the bibliography data [39] and the results of the current system are illustrated in the Table 6 below.

**Table 6.** Calculation of the Energy Provided (EP) during the life cycle of the system in (kWh).

Collector	Storage	Heat exchanger	Total installation
38902,95	14773,33	2586	56262,28

The payback duration (PD) shows how many years it takes the present DHW to create enough energy to match the energy used over its life cycle. The definition of PD is the (EP) over the Energy Saved during the System Life Cycle (ES). The PD stands for an essential need for both the installation's setup and operation. The following equation is used to compute the (PD):

$$PD = \frac{EP}{ES} \quad (3)$$

The amount of energy saved was computed using a primary energy conversion factor based on the kind of fuel utilized, together with the effectiveness of the auxiliary heating system that the present solar system is replacing. Table 7 below shows the results of calculating the ES and PD for each installation. Every year of the installation's service life, the energy payback calculation has been taken into account as a constant. It was discovered that the electrical system efficiency for the existing system is around 56 MWh/year.

The expensive shipping and delivery of the solar system component is the cause of the comparatively long payback time. With the anticipated increase in demand for solar products, these costs are anticipated to decrease. The life cycle savings, which indicates the money the owner would save by installing the solar system instead of buying power to meet his heat energy demands, is another element that highlights the importance of employing thermal solar systems.

**Table 7.** Calculation of the energy provided (EP) during life cycle of the system in (kWh).

System cost	156000 \$
Installation cost	17160 \$
Up-holding cost	6000 \$
Total Electricity saving	56.3 MWh/yr
LCF saving based on electricity saving	11252 \$

## 5. Further discussion

The extension of energy measurement saving in the whole campus on the basis of the results of current campus case study (camp 17) proves that the implementation of the two ESM1 and ESM2 (PV and solar thermal systems) can generate a very important potential of energy saving.

In fact, for the PV system, the project involves installing a PV generator for self-consumption. The power to be installed should make it possible, initially, to fill a maximum of 20% of the consumption of the campuses. The power to be installed is summarized in Figure (23a) below.

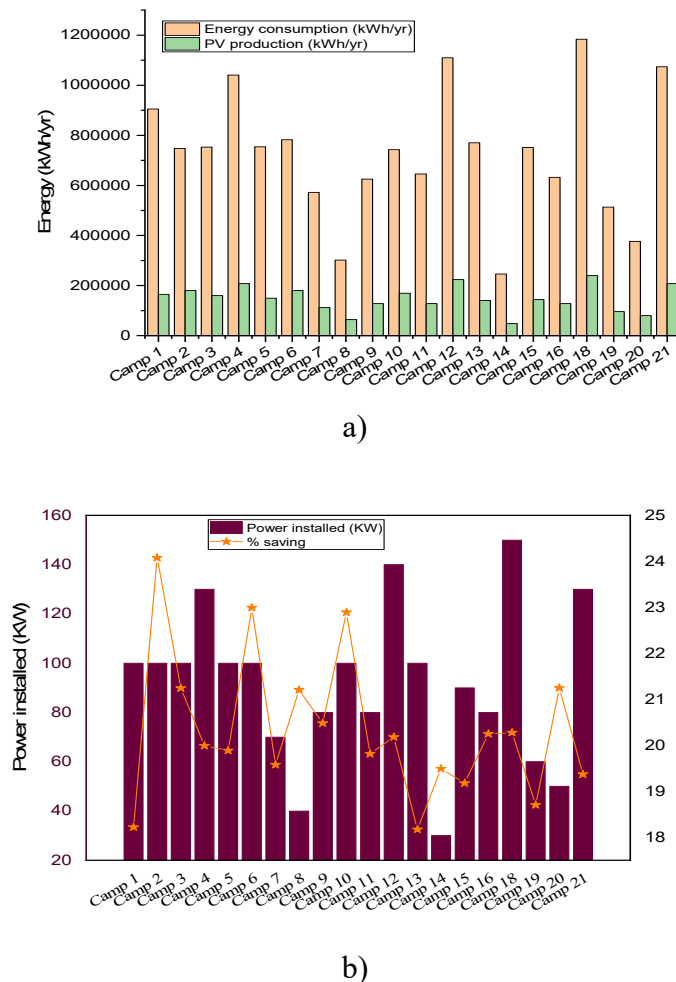
**Figure 23.** Generalized PV Earnings on energy consumption for each campus.

According to the simulation of the result previously for the campus case study, generalizing simulations have been done for the other campuses on the basis on the energy diagnostic presented previously. Figure 23 presented the results of the PV production for each campus with comparison with the energy consumption profile for each one of them. Also, the Figure contains the results of the sizing of PV generators and energy saving for each campus on the basis of the load curve found by the network analyzer. The profiles energy consumption ranged from 246,3 MWh/yr (campus 14) as a minimum to 1183.7 MWh/yr as maximum (campus 18), due to the different capacity and surface of each campus and also due to many factors such as energy equipment and management way for each campus. Besides, the PV generators produced around 22% for the total energy consumption (48000 kWh/yr) for campus 14 and 224 MWh/yr for campus 12 which the power necessary for reached this energy saving is varied from 30 KW to 150 KW as illustrated in Figure (23a) and (23b).

On the other hand, for the thermal action ESM2, only 5 campuses out of 21 have solar installations for the production of domestic hot water. The generalizing of the use of solar collectors to other campuses is addressed only for seven campuses that used the fuel for DHW production by using the boiler. The efficiency of the boiler was taken as 90% while the production of hot water should be at 55 °C as illustrated in the Table 8 below.

**Table 8.** Results of estimates of DHW consumption in campuses.

Campus	DHW diesel Litre/yr	DHW diesel kWh/yr	DHW production at 55 °C m <sup>3</sup> /yr	Current cold water consumption m <sup>3</sup> /yr
Camp 14	16 000	160 000	3 100	35 299
Camp 16	26 000	260 000	5 038	81 414
Camp 6	140 000	1 400 000	27 129	166 827
Camp 7	304 000	3 040 000	58 909	109 784
Camp 2	9 000	90 000	1 744	70 057
Camp 19	61 000	610 000	11 821	83 822
Camp 4	10 500	105 000	2 035	74 853

The hot water production of the seven campuses (see table below) was estimated at 109.7 m<sup>3</sup>/year, for a diesel consumption of 566.5 m<sup>3</sup>/year. The details of the estimates are recorded in the following table. The Campus 6 and 7 consume the largest quantities of water due to the high number of staff accommodation in these two campuses. The necessary investment was calculated assuming a price of 786 \$ including per square meter, including installation.

The production of DHW by solar thermal will provide 67% of needs as illustrated in the table below, i.e., the equivalent of 424,5 m<sup>3</sup>/year of diesel. The corresponding saving is 417767 \$ per year. The estimated savings to be made are presented in the following table.

**Table 9.** Savings from the use of ECS in campuses.

Campus	Heat production (kWh)	Surface thermal collector system (m <sup>2</sup> )	Diesel savings (litre/yr)	Diesel savings (\$/yr)	Diesel savings (en%)
Camp 14	107 900	90	11 989	113 29	67%
Camp 16	176 100	146	19 567	131 33	68%
Camp 6	955 600	778	106 178	1 081 52	68%
Camp 7	2 027 100	1 650	225 233	2 294 23	67%
Camp 2	62 100	47	6 900	63 20	69%
Camp 19	419 900	342	46 656	475 23	69%
Camp 4	71 400	54	7 933	79 33	68%

To end, the execution of the ESM1 and ESM2 into the energy sector can achieved a very energy saving potential for the campuses. Indeed, without the execution of the ESM1 and ESM2, the electricity consumption performance indicator per bed varied from 167 kWh/bed per year to a maximum of 1342 kWh/bed/yr with an average of 435 kWh/bed per year in the whole campuses as illustrated in the Figure 24.

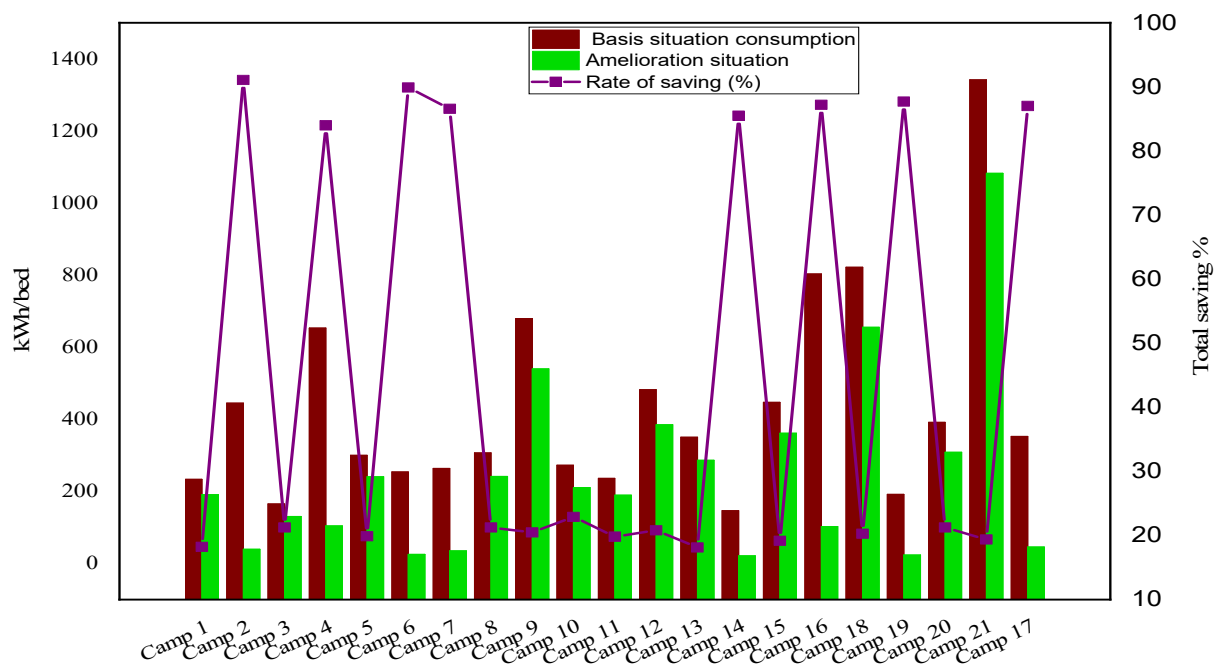
**Figure 24.** Performance indicator ratio in kWh/bed/year.

Besides, the results of the current study indicated and prove that the integration of renewable energy into the energy system of the campuses by applying the ESM1 and ESM2 can reduce its energy consumption. In fact, the results prove that the performance indicator kWh/bed/year shows a very percentage of saving energy as illustrated in Figure 24 which is 248 kWh/bed per year which represents an average energy saving of 56%.

## 6. Conclusions

Public buildings are energy-intensive consumers. The study supports the Moroccan government's exemplarity in terms of energy efficiency and sustainable development in the public building by presenting the results of a detailed energy performance analysis of more than 20 university campuses in Morocco in different locations (climatic zone), which concluded that approximately 80% of the energy consumed on university campuses is designated to electric equipment and hot water for sanitary use. The current study has analyzed the use of different forms of energy, i.e., electrical from the grid and thermal from combustible.

The paper has studied the integration of two ESM, i.e., the PV and thermal system for a case study as a pilot campus detailed in order to generalize on all campuses. Indeed, three scenarios have been studied for ESM1 in order to find the optimal scenario. Besides, the ESM2 (thermal system) has been studied for hot water production by replacing the diesel boiler.

The conclusions findings from the study are listed below:

- The energy saving by the implementation of the PV system production in the pilot campus allows saving about 51% for SC1 (30 kWp), 84% for SC2 (60 KWp) and 94% for SC3 (80 KWp) on energy consumption.
- The results of the bill analysis concerning the pilot campus reached an average of 10000 \$ per month with 56000 kWh/month. The economic benefits results indicate that the PV scenarios studied can cover a rate of 24%, 41% and 52% for SC1, SC2 and SC3 respectively on the billed energy.
- The implementation of solar thermal for hot water for the case study achieved an average solar fraction of 55% during the worst climatic condition. The ESM2 system has reached a maximum of 60% when the pilot campus works on full-time and at full capacity.
- The Moroccan campuses (21) consume around 17443 MWh (electrical form) per year with a bill of 2406425 \$ a year. The combustible consumption reached 632923 liters per year with a bill of 638148 \$ a year. The results indicated that the energy consumption index has an average of 700 kWh/ped/yr which is equivalent to 100 \$/bed, knowing that the number total of the bed is equal to 42978 and it's not changed during the study.
- The extension of energy measurement saving in the whole campus on the basis of the results of pilot campus case study prove that the implementation of the two ESM1 and ESM2 generate a very important potential for energy saving. In fact, for the ESM1, the results prove that installing PV generators can reach a self-consumption of 20% of the total consumption of the campuses.
- The energy consumption index per room has an average of around 1705 (kWh/room/yr). The results indicated that the integration of ESM1 and ESM2 allows for achieving an indicator of 1360 kWh/room per year. Knowing that the total room is equal to 11700 and the average rate of student occupancy per room is equal to 3,7 bed per room.

To end, the building sector is among the most energy-intensive sectors in Morocco with energy consumption of up to 33%, divided into 7% for commercial buildings and 26% for residential buildings. However, further effort work in this field is still needed to develop standardized procedures for decreasing the energy consumption and more exploitation of Renewable energy sources in this context.



## Use of AI tools declaration

The authors declare that the research conducted and presented in the current paper and submitted to AIMS Journal, have not utilized AI tools in any stages of the research process.

## Conflict of interest

The authors whose names listed in the paper certify that they have NO affiliations with or involvement in any organization or entity with any financial interest (such as honoraria; educational grants; participation in speakers' bureaus; membership, employment, consultancies, stock ownership, or other equity interest; and expert testimony or patent-licensing arrangements), or non-financial interest (such as personal or professional relationships, affiliations, knowledge or beliefs) in the subject matter or materials discussed in this manuscript.

## References

1. Wai CW, Abdul HM, Ting LS (2011) Energy management key practices: A proposed list for Malaysian universities. *Int J Energy Environ* 2: 749.
2. Allouhi A, El Fouih Y, Kousksou T, et al. (2015) Energy consumption and efficiency in buildings: Current status and future trends. *J Cleaner Produc* 109: 118–130. <https://doi.org/10.1016/j.jclepro.2015.05.139>
3. Parameshwaran R, Kalaiselvam S, Harikrishnan S, et al. (2012) Sustainable thermal energy storage technologies for buildings: A review. *Renewable Sustainable Energy Rev* 16: 2394–2433. <https://doi.org/10.1016/j.rser.2012.01.058>
4. International Energy Agency (IEA) (2016) Energy efficiency market report. <https://doi.org/10.1787/9789264266100-en>
5. Choukri K, Naddami A, Hayani S (2017) Renewable energy in emergent countries: Lessons from energy transition in Morocco. *Energy Sustainability Soc.* <https://doi.org/10.1186/s13705-017-0131-2>
6. Alhamwi A, Kleinhans D, Weitemeyer S (2015) Moroccan National Energy Strategy reviewed from a meteorological perspective. *Energy Strategy Rev* 6: 39–47. <https://doi.org/10.1016/j.esr.2015.02.002>
7. Harrouni KE, Filali M, Kharmich H (2018) Energy efficient houses meeting both bioclimatic architecture principles and Moroccan thermal regulation. In *2018 6th International Renewable and Sustainable Energy Conference (IRSEC), Rabat, Morocco*, 1–8. <https://doi.org/10.1109/IRSEC.2018.8702273>
8. Merini I, Molina-García A, García-Cascales MS, et al. (2019) Energy efficiency regulation and requirements: Comparison between Morocco and Spain. In *Advanced Intelligent Systems for Sustainable Development (AI2SD'2018)*, Springer International Publishing: Cham, Switzerland, 197–209. [https://doi.org/10.1007/978-3-030-12065-8\\_19](https://doi.org/10.1007/978-3-030-12065-8_19)
9. International Energy Agency (2019) Morocco renewable energy target 2030. Technical report: Paris, France. Available from: <https://www.iea.org/policies/6557-morocco-renewable-energy-target-2030>.

10. International Energy Agency (2016) Partner country series—Clean energy technology assessment methodology pilot study: Morocco. *Technical report: Paris, France*. Available from: <https://www.iea.org/reports/partner-country-series-clean-energy-technology-assessment-methodology-pilot-study-morocco>.
11. Pereira LD, Raimondo D, Corgnati SP, et al. (2014) Energy consumption in schools—A review paper. *Renewable Sustainable Energy Rev* 40: 911–922. <https://doi.org/10.1016/j.rser.2014.08.010>
12. Sait HH (2013) Auditing and analysis of energy consumption of an educational building in hot and humid area. *Energy Convers Manage* 66: 143–152. <https://doi.org/10.1016/j.enconman.2012.10.005>
13. Semprini G, Marinosci C, Ferrante A, et al. (2016) Energy management in public institutional and educational buildings: The case of the school of engineering and architecture in Bologna. *Energy Build* 126: 365–374. <https://doi.org/10.1016/j.enbuild.2016.05.009>
14. Singh H, Seera M, Idin MAM (2012) Electrical energy audit in a Malaysian university—A case study. In *Power and Energy (PECon), 2012 IEEE International Conference on IEEE*, 616–619. <https://doi.org/10.1109/PECon.2012.6450288>
15. Escobedo A, Briceño S, Juárez H, et al. (2014) Energy consumption and GHG emission scenarios of a university campus in Mexico. *Energy Sustainable Dev* 18: 49–57. <https://doi.org/10.1016/j.esd.2013.10.005>
16. Division Paris City Hall-Department of Green Spaces and the Environment-Urban Ecology Agency Climate-Energy Division (2014) Energy renovation of Parisian schools. Available from: [https://cdn.locomotive.works/sites/5ab410c8a2f42204838f797e/content\\_entry5ae2f905a2f4220ae645f026/5af7316614ad660b652531de/files/Paris\\_-\\_Paris\\_Climate\\_Action\\_Plan.pdf?1526890697](https://cdn.locomotive.works/sites/5ab410c8a2f42204838f797e/content_entry5ae2f905a2f4220ae645f026/5af7316614ad660b652531de/files/Paris_-_Paris_Climate_Action_Plan.pdf?1526890697).
17. Thewes A, Maas S, Scholzen F, et al. (2014) Field study on the energy consumption of school buildings in Luxembourg. *Energy Build* 68: 460–470. <https://doi.org/10.1016/j.enbuild.2013.10.002>
18. Alajmi A (2012) Energy audit of an educational building in a hot summer climate. *Energy Build* 47: 122–130. <https://doi.org/10.1016/j.enbuild.2011.11.033>
19. Butala V, Novak P (1999) Energy consumption and potential energy savings in old school buildings. *Energy Build* 29: 241–246. [https://doi.org/10.1016/S0378-7788\(98\)00062-0](https://doi.org/10.1016/S0378-7788(98)00062-0)
20. Dimoudi A, Kostarela P (2009) Energy monitoring and conservation potential in school buildings in the C' climatic zone of Greece. *Renewable Energy* 34: 289–296. <https://doi.org/10.1016/j.renene.2008.04.025>
21. Hamdaoui S, Mahdaoui M, Allouhi A, et al. (2018) Energy demand and environmental impact of various construction scenarios of an office building in Morocco. *J Clean Prod* 188: 113–124. <https://doi.org/10.1016/j.jclepro.2018.03.298>
22. Guechchati R, Moussaoui MA, Mezrhab A, et al. (2012) Improving the energy-efficient envelope design for moroccan houses. *Int J Ambient Energy* 33: 184–192, <https://doi.org/10.1080/01430750.2012.686199>
23. Lafqir FE, Sobhy I, Benhamou B, et al. (2020) Thermal performance of passive techniques integrated to a house and the concept of passive house in the six climates of Morocco. *Sci Technol Built Environ* 26: 1490–1508. <https://doi.org/10.1080/23744731.2020.1805983>

24. Good C, Andresen I, Hestnes AG, et al. (2015) Solar energy for net zero energy buildings—A comparison between solar thermal, PV and photovoltaic-thermal (PV/T) systems. *Sol Energy* 122: 986–996. <https://doi.org/10.1016/j.solener.2015.10.013>
25. Chegari B, Tabaa M, Moutaouakkil F, et al. (2020) Local energy self-sufficiency for passive buildings: Case study of a typical Moroccan building. *J Build Eng* 29: 101164. <https://doi.org/10.1016/j.jobe.2019.101164>
26. Harkouss F, Fardoun F, Biwole PH (2018) Passive design optimization of low energy buildings in different climates. *Energy* 165: 591–613. <https://doi.org/10.1016/j.energy.2018.09.019>
27. Jamaludin AA, Mahmood NZ, Ilham Z (2017) Performance of electricity usage at residential college buildings in the University of Malaya campus. *Energy Sustainable Dev* 40: 85–102. <https://doi.org/10.1016/j.esd.2017.07.005>
28. ADEREE (2015) The energy efficiency vision of the Kingdom.
29. MEMEE (2016) Minister speech during photovoltaic conference and exhibition.
30. Division Paris City Hall-Department of Green Spaces and the Environment-Urban Ecology Agency Climate-Energy Division (2016) Energy renovation of Parisian schools. Available from: <https://cdn.paris.fr/paris/2019/07/24/1a706797eac9982aec6b767c56449240.pdf>.
31. Allouhi A, Boharb A, Saidur R, et al. (2018) Energy Auditing. *Compr Energy Syst* 5: 1–44 <https://doi.org/10.1016/B978-0-12-809597-3.00503-4>
32. Lytras K, Caspar C (2005) Energy Audit Models. SAVE-project AUDIT II, Topic Report.
33. D’Adamo I (2018) The profitability of residential photovoltaic systems. A new scheme of subsidies based on the price of CO<sub>2</sub> in a developed PV market. *Soc Sci* 7: 148. <https://doi.org/https://doi.org/10.3390/socsci7090148>
34. GSE (2020) Annual reports. Available from: <https://www.gse.com.ge/communication/reports/annual-reports>.
35. Ouhammou B, Mohammed A, Sliman S, et al. (2022) Experimental conception and thermo-energetic analysis of a solar biogas production system. *Case Stud Thermal Eng* 30: 101740. <https://doi.org/10.1016/j.csite.2021.101740>
36. Ouhammou B, Mohammed A, Frimane A, et al. (2019) A new system design and analysis of a solar bio-digester unit. *Energy Convers Manage* 198: 111779. <https://doi.org/10.1016/j.enconman.2019.111779>
37. Bohm B (2013) Production and distribution of domestic hot water in selected Danish apartment buildings and institutions: analysis of consumption, energy efficiency and the significance for energy design requirements of buildings. *Energy Convers Manage* 67: 152–159. <https://doi.org/10.1016/j.enconman.2012.11.002>
38. Raugei M, Bargigli S, Ulgiati S, et al. (2007) Life cycle assessment and energy pay-back time of advanced photovoltaic modules: CdTe and CIS compared to poly-Si. *Energy* 32: 1310–1318. <https://doi.org/10.1016/j.energy.2006.10.003>

- 
39. Ouhammou B, Gargab FZ, Frimane A, et al. (2022) Modeling of a bio-methane solar system driven by solar energy and heat pump. 158: 106378. <https://doi.org/10.1016/j.biombioe.2022.106378>



AIMS Press

© 2023 the Author(s), licensee AIMS Press. This is an open access article distributed under the terms of the Creative Commons Attribution License (<http://creativecommons.org/licenses/by/4.0>)